



Project:
Project #: 609

Issue Date: 03 FEB 2017
Revision Date: 29 NOV 2016 (1)

ITEM TYPES

- Seating
- Casegoods
- Upholstery
- Lighting
- Fixed Lighting
- Miscellaneous
- Bedding
- Mirror
- Draperies

Project:
Project #: 609

Issue Date: 03 FEB 2017
Revision Date: 29 NOV 2016 (1)

FF&E SPECIFICATIONS





NOTICE ON SPECIFICATIONS

1. MANUFACTURER TO NOTIFY TBEA OF ANY ERROR OR CONFLICT IN SPECIFICATIONS AS INDICATED.
2. IMAGE MAY NOT REFLECT CORRECT COLOR
3. SEND FINISH SAMPLE(S) TO TBEA FOR APPROVAL PRIOR TO INSTALLATION / PURCHASING
4. UPHOLSTERY FOAM OR CUSHIONING MUST BE CERTIFIED TO MEET OR EXCEED CAL 117E AND CMHR BARRIER WRAP AS REQUIRED
BY LOCAL AND STATE FIRE CODES FOR USE IN HOTELS & OTHER PUBLIC SPACES
5. ALL EXPOSED WOOD TO BE SELECT KILN-DRIED HARDWOOD. ALL STRESS JOINTS TO BE CORNER BLOCKED, GLUED, DOUBLE-DOWelled OR SCREWED. CONSTRUCTION AND FRAMING MUST BE CONTRACT QUALITY.
6. VERIFY QUANTITY AND COM YARDAGE REQUIREMENT PRIOR TO PURCHASING
7. SUPPLIED BY: REFER TO MATRIX
8. INSTALLED BY: REFER TO MATRIX







1133 Olivette Executive Parkway • St. Louis, MO 63132 • Phone (314) 727-7000 • Fax (314) 645-0761
www.thaldenboydemery.com







Construction Standards

- Kiln-dried hardwood frames, double-dowelled joinery, and solid-wood corner blocking.
- High-resilience foam cushion cores: standard seat cushion rating is 2.5 density with 30-pound compression; standard for seat backs is 1.8 density with 25-pound compression.
- Nail heads applied by hand, instead of cheaper strip nail heads.
- Standard upholstery materials adhere to California flame retardance Technical Bulletin (TB) 117; upon request we offer TB 133 compliance with applied fire stop fabric.
- Rigorous stock selection process to insure the removal of all defects.
- Standard veneer thickness set at .6mm, twice the industry standard thickness.
- We insist on the use of MDF substrates instead of particleboard in primary case construction for its superior machinability, fastener hold, resistance to impact damage, and dimensional consistency and stability.
- Use of MDF with low formaldehyde EN2. (EN1, EN0, or 0 VOC are available if specified.)
- Case interiors = solid-wood frame dust panels at case bottom and between drawers.
- Case backs are a minimum of 8mm in thickness, but for larger cases use of 10mm or thicker panels; back panels always screwed in place rather than stapled to reduce the risk of fastener failure.
- Use Tongue-and-groove joinery in frame-and-panel assemblies in locations such as doors, case sides, fully captured backs and tabletops.
- Standard drawer boxes = dovetail joinery with a non-integral face fastened in place with cleanly countersunk screws (also referred to as a “five-sided drawer box”).
- Standard drawer slide = self-return, soft-close under mount $\frac{3}{4}$ extension.
- Heavy-duty leveling glides.







Control #	Description	Area / Location	Mfr / Vendor	Special Instructions	Image
Seating					
CH-1.H	<p>Typical King Guestroom Lounge Chair Description: CUSTOM LOUNGE CHAIR</p> <p>Model #: SP20485-05</p> <p>Finish: Black</p> <p>Dimensions: 32.75"W x 31.75"D x 35"H / 18" Seat Height, 24" Arm Height</p> <p>COM yardage: 8.25 yds railroad random or 9.25 yds non-railroad random</p> <p>Notes: Semi attached, loose seat, tapered wood legs, small welt at arms, back and base, nylon glides</p>		<p>Kellex Seating 33390 Liberty Parkway North Ridgeville, OH 44039 USA P 440-327-4428 Contact Default</p> <p>Susan Faulhaber 715 Briar Fork Rd. Des Peres, MO 63131 USA P 314-909-7172 F 314-909-7173 Contact Default</p>	<p>* Nylon Glides</p> <p>* Stretchers</p>	
CH-3.H	<p>Ottoman at Lounge Chair Description: Oliver Cube Ottoman</p> <p>Model #: 07303-00</p> <p>Finish:</p> <p>Dimensions: 18"W X 18"D X 18"H</p> <p>COM yardage: 2 yards per ottoman</p>		<p>Kellex Seating 33390 Liberty Parkway North Ridgeville, OH 44039 USA P 440-327-4428 Contact Default</p> <p>Susan Faulhaber 715 Briar Fork Rd. Des Peres, MO 63131 USA P 314-909-7172 F 314-909-7173 Contact Default</p>	<p>* Nylon Glides</p> <p>* Stretchers</p>	
CH-5.H	<p>Lounge Chair - Double Queen Rooms Description: Custom Antoinette Chair</p> <p>Model #: SP24324-05</p> <p>Finish: Black</p> <p>Dimensions: 28.5"W x 30.5"D x 36.5"H</p> <p>Seat Height: 18"</p> <p>Arm Height: N/A</p> <p>COM yardage: 5.5 yds railroad random or 5 yds non railroad random</p> <p>Notes: Standard dimensions, extend arms to front of chair, no channels on in back</p>		<p>Kellex Seating 33390 Liberty Parkway North Ridgeville, OH 44039 USA P 440-327-4428 Contact Default</p> <p>Susan Faulhaber 715 Briar Fork Rd. Des Peres, MO 63131 USA P 314-909-7172 F 314-909-7173 Contact Default</p>	<p>* Nylon Glides</p> <p>* Stretchers</p>	
CH-6.H	<p>Dining Chair Description: Custom Armless Dining Chair; Added side stretchers</p> <p>Model #: TBD</p> <p>Wood Finish: Black</p> <p>Dimensions: 23.5"W x 38"H x 25.5"D</p> <p>COM yardage: TBD</p> <p>Seat Height: 19.5"</p> <p>Seat Depth: 19"</p> <p>Stretcher Finish: TBD</p>		<p>Kellex Seating 33390 Liberty Parkway North Ridgeville, OH 44039 USA P 440-327-4428 Contact Default</p> <p>Susan Faulhaber 715 Briar Fork Rd. Des Peres, MO 63131 USA P 314-909-7172 F 314-909-7173 Contact Default</p>	<p>* Nylon Glides</p> <p>* Stretchers</p>	
CH-7.H	<p>Desk Chair Description: Channel Back Ergo Guest Chair with Chrome Base and Black Casters</p> <p>Model #: ER13500-MNA TENNIE ERGO CHAIR W/ METAL BASE</p> <p>Finish: Chrome</p> <p>Dimensions: 23.75"W x 24.25"D x 37"-39.5"H</p> <p>COM yardage: 1.25 yds railroaded random or 1.5 yards non-railroaded</p> <p>Arm Height: N/A</p> <p>Seat Height: 18.75"-21.5"</p>		<p>Kellex Seating 33390 Liberty Parkway North Ridgeville, OH 44039 USA P 440-327-4428 Contact Default</p> <p>Susan Faulhaber 715 Briar Fork Rd. Des Peres, MO 63131 USA P 314-909-7172 F 314-909-7173 Contact Default</p>	<p>* Nylon Glides</p> <p>* Stretchers</p>	





Control #	Description	Area / Location	Mfr / Vendor	Special Instructions	Image
CH-8.H	Luggage Bench - with Back Description: Custom luggage bench with metal back rail. Tightly upholstered top, metal base with straight metal legs, metal framed back with open space. Model #: SP24168-15 Finish: Metal Dimensions: 36"W x 18"D x 22"H COM yardage: 3 yds per luggage bench		Kellex Seating 33390 Liberty Parkway North Ridgeville, OH 44039 USA P 440-327-4428 Contact Default Susan Faulhaber 715 Briar Fork Rd. Des Peres, MO 63131 USA P 314-909-7172 F 314-909-7173 Contact Default	* Nylon Glides * Stretchers	
CH-9.H	Luggage Bench - without back Description: Custom Luggage bench with metal base. Tightly upholstered top, metal base with straight metal legs. Model #: SP24167-15 Finish: Metal Dimensions: 36"W x 18"D x 22"H COM yardage: 3 yds per bench		Kellex Seating 33390 Liberty Parkway North Ridgeville, OH 44039 USA P 440-327-4428 Contact Default Susan Faulhaber 715 Briar Fork Rd. Des Peres, MO 63131 USA P 314-909-7172 F 314-909-7173 Contact Default	* Nylon Glides * Stretchers	
CH-10.H	Suites Lounge Chair Description: Jaxon Chair Model #: N3522 Finish: Gun Metal only Dimensions: 29-1/2"W x 32-1/2"D x 31-1/2"H. 17"SH x 24"AH x 24-1/2"SD x 22-1/2"BA COM yardage: 6 yds per chair based on 54" non-repeat fabric Construction: Sinuous Spring Cushion: Luxe Down		Bernhardt Textiles 1839 Morganton Blvd. P.O. Box 740 Lenoir, NC 28645 USA P 828-758-9811 Karma Lamping USA Contact Default	* Nylon Glides * Stretchers	
CH-11.H	Queen Sofa Sleeper Description: Custom Queen Sleeper. 2 total 14" Welted Accent Pillows (Fiber Filled), 2 Loose Reversible Box Style Seat Cushions-No Welt (1.8hr), 2 Semi-Attached Box Style Back Cushions-No Welt (Foam with Fiber Wrap). Model #: SP24165-50 Dimensions: 81"W x 36"D x 34"H COM yardage: Sofa Body: 16.5 yds railroad random or 19 yds non-railroad random. Pillows: 2 yds. Arm Style: Tightly upholstered Base: Wood sleigh base to extend up front and back of arms (Max 3.5" Leg height allowed for sleepers) Sofa Mattress: L&P Classic square 3568 with Kellex Standard 5" Platinum Mattress		Kellex Seating 33390 Liberty Parkway North Ridgeville, OH 44039 USA P 440-327-4428 Contact Default Susan Faulhaber 715 Briar Fork Rd. Des Peres, MO 63131 USA P 314-909-7172 F 314-909-7173 Contact Default	* Nylon Glides * Stretchers * Backs to extend 4" above 30"H back rail for 34" overall height	
CH-14.H	Pillow For Sofa Sleepers Description: 14" Welted Accent Pillows Model #: 9000-14 Dimensions: 14" x 14" COM yardage: 1 yd per pillow		Kellex Seating 33390 Liberty Parkway North Ridgeville, OH 44039 USA P 440-327-4428 Contact Default Susan Faulhaber 715 Briar Fork Rd. Des Peres, MO 63131 USA P 314-909-7172 F 314-909-7173 Contact Default	* Nylon Glides * Stretchers	
CH-15.H	Ottoman at Sofa Sleepers Description: Oliver Cube Ottoman Model #: 07303-00 Dimensions: 18"W x 18"D x 18"H COM yardage: 2 yds per ottoman Seat Height: 18" Arm Height: N/A		Kellex Seating 33390 Liberty Parkway North Ridgeville, OH 44039 USA P 440-327-4428 Contact Default Susan Faulhaber 715 Briar Fork Rd. Des Peres, MO 63131 USA P 314-909-7172 F 314-909-7173 Contact Default	* Nylon Glides * Stretchers	





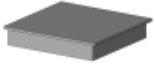
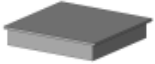
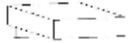

Control #	Description	Area / Location	Mfr / Vendor	Special Instructions	Image
Casegoods					
CG-1.H	<p>King Headboard Description: Custom Tufted King Headboard with Backlit Acrylic Panel</p> <p>Acrylic Finish: Envel Rice Paper - Weekend Sky</p> <p>Wood Finish: Stain to match Arborite - W448 LQ</p> <p>Dimensions: 7'-0" W x 4" D x 7'-2"H</p> <p>Light Box Description: Light Box Panel to be hinged at top along back edge. Light to be mounted on the under side of the hinged top. Nightstand back panels to be coordinated as they will all share a single light strip.</p> <p>COM : 5 yds</p>		<p>HF Collection 465 Forbes Blvd South San Francisco , CA 94080 USA P 650-952-2546 F 650-952-2681 Contact Default</p> <p>Sarah Turner USA P 650-952-2546 F 650-952-2681 Contact Default</p>	<p>* Upholstery to be Attached: F-1.H Custom Silica ML5442-A2</p> <p>* Please Refer to TBE Standard Construction Standards</p>	
CG-2.H	<p>Queen Headboard Description: Custom Tufted Queen Headboard with Backlit Acrylic Panel</p> <p>Acrylic Finish: Envel Rice Paper - Weekend Sky</p> <p>Wood Finish: Stain to match Arborite - W448 LQ</p> <p>Dimensions: 5'-6" L x 4" D x 7'-2" H</p> <p>Light Box Description: Light Box Panel to be hinged at top along back edge. Light to be mounted on the under side of the hinged top. Nightstand back panels to be coordinated as they will all share a single light strip.</p> <p>COM: 4 yds</p>		<p>HF Collection 465 Forbes Blvd South San Francisco , CA 94080 USA P 650-952-2546 F 650-952-2681 Contact Default</p> <p>Sarah Turner USA P 650-952-2546 F 650-952-2681 Contact Default</p>	<p>* Please Refer to TBE Standard Construction Standards</p>	
CG-3.H	<p>24" Nightstand/Panel Combo Description: Custom 24" Wide Nightstand, Wall panel with integral light box; Plug-ins & Switches included.</p> <p>Finish: Stain to match Arborite - W448 LQ</p> <p>Dimensions: 2'-0" W x 9'-0" H</p> <p>Hardware: Similar to image provided</p> <p>Solid Surface: Cambria Edinborough Top</p> <p>Solid Surface Edge Profile: Eased Edge</p> <p>Solid Surface Thickness: 2CM</p>		<p>HF Collection 465 Forbes Blvd South San Francisco , CA 94080 USA P 650-952-2546 F 650-952-2681 Contact Default</p> <p>Sarah Turner USA P 650-952-2546 F 650-952-2681 Contact Default</p>	<p>* Please Refer to TBE Standard Construction Standards</p>	
CG-4.H	<p>30" Nightstand/Panel Combo Description: Custom 30" Wide Nightstand, Wall panel with integral light box; Plug-ins & Switches included.</p> <p>Finish: Stain to match Arborite - W448 LQ</p> <p>Dimensions: 2'-6"W x 9'-0"H</p> <p>Hardware: Similar to image provided</p> <p>Solid Surface Top: Cambria Edinborough Top</p> <p>Solid Surface Edge Profile: Eased Edge</p> <p>Solid Surface Thickness: 2CM</p>		<p>HF Collection 465 Forbes Blvd South San Francisco , CA 94080 USA P 650-952-2546 F 650-952-2681 Contact Default</p> <p>Sarah Turner USA P 650-952-2546 F 650-952-2681 Contact Default</p>	<p>* Please Refer to TBE Standard Construction Standards</p>	







Control #	Description	Area / Location	Mfr / Vendor	Special Instructions	Image
CG-5.H	<p>36" Nightstand/Panel Combo (ADA) Description: 36" Wide Nightstand, Wall Panel with integral light box; Plug-ins & Switches included.</p> <p>Finish: Stain to match Arborite - W448 LQ</p> <p>Dimensions: 3'-0"W x 9'-0"H</p> <p>Hardware: Similar to image provided</p> <p>Solid Surface Top: Cambria Edinborough Top</p> <p>Solid Surface Edge Profile: Eased Edge</p> <p>Solid Surface Thickness: 2CM</p>		<p>HF Collection 465 Forbes Blvd South San Francisco , CA 94080 USA P 650-952-2546 F 650-952-2681 Contact Default</p> <p>Sarah Turner USA P 650-952-2546 F 650-952-2681 Contact Default</p>	* Please Refer to TBE Standard Construction Standards	
CG-6.H	<p>King Bed Base Description: King Custom Platform for Bed</p> <p>Laminate: Arborite - W448 LQ</p> <p>Dimensions: 7'-0"W x 7'-4"L x 1'-4"H</p>		<p>HF Collection 465 Forbes Blvd South San Francisco , CA 94080 USA P 650-952-2546 F 650-952-2681 Contact Default</p> <p>Sarah Turner USA P 650-952-2546 F 650-952-2681 Contact Default</p>	* Please Refer to TBE Standard Construction Standards	
CG-7.H	<p>Queen Bed Base Description: Queen Custom Platform for Bed</p> <p>Finish: Stain to match Arborite - W448 LQ</p> <p>Dimensions: 5'-0"W x 7'-4"L x 1'-4"H</p>		<p>HF Collection 465 Forbes Blvd South San Francisco , CA 94080 USA P 650-952-2546 F 650-952-2681 Contact Default</p> <p>Sarah Turner USA P 650-952-2546 F 650-952-2681 Contact Default</p>	* Please Refer to TBE Standard Construction Standards	
CG-8.H	<p>Double Queen Power Shelf Description: Custom floating wall shelf with integral power; Stained to match casegoods</p> <p>Finish: Stain to match Arborite - W448 LQ</p> <p>Dimensions: 6" W X 10" D X 2.5" OAH</p> <p>Hardware: Wall mounting brackets</p> <p>Notes: Provide (2) power ready outlets</p>		<p>HF Collection 465 Forbes Blvd South San Francisco , CA 94080 USA P 650-952-2546 F 650-952-2681 Contact Default</p> <p>Sarah Turner USA P 650-952-2546 F 650-952-2681 Contact Default</p>	* Please Refer to TBE Standard Construction Standards	
CG-9.H	<p>Dresser - 72"W Description: Custom Six Drawer Dresser</p> <p>Finish: Stained To Match Arborite W-448 LQ</p> <p>Dimensions: 6'-0"W X 1'-7"D X 2'-6"H</p> <p>Hardware: Similar to image provided</p> <p>Drawer Safe: SAFEMARK SYSTEMS DNX 5.4</p> <p>Solid Surface Top: Cambria Edinborough Top</p> <p>Solid Surface Edge Profile: Eased Edge</p> <p>Solid Surface Thickness: 2CM</p>		<p>HF Collection 465 Forbes Blvd South San Francisco , CA 94080 USA P 650-952-2546 F 650-952-2681 Contact Default</p> <p>Sarah Turner USA P 650-952-2546 F 650-952-2681 Contact Default</p>	* Please Refer to TBE Standard Construction Standards	





Control #	Description	Area / Location	Mfr / Vendor	Special Instructions	Image
CG-10.H	<p>Dresser - 54"W Suites Description: Custom Dresser</p> <p>Finish: Stained To Match Aborite W-448 LQ</p> <p>Dimensions: 4'-6"W X 1'-7"D X 2'-6"H</p> <p>Hardware: Similar to image provided</p> <p>Drawer Safe: SAFEMARK SYSTEMS DNX 5.4</p> <p>Solid Surface Top: Cambria Edinborough Top</p> <p>Solid Surface Edge Profile: Eased Edge</p> <p>Solid Surface Thickness: 2CM</p>		<p>HF Collection 465 Forbes Blvd South San Francisco , CA 94080 USA P 650-952-2546 F 650-952-2681 Contact Default</p> <p>Sarah Turner USA P 650-952-2546 F 650-952-2681 Contact Default</p>	* Please Refer to TBE Standard Construction Standards	
CG-11.H	<p>Desk LH - 48"W Description: Custom Cantilevered Desk</p> <p>Finish: Stained To Match Aborite W-448 LQ</p> <p>Dimensions: 4'-0"W X 1'-7"D X 34"OAH</p> <p>Hardware: Similar to image provided</p> <p>Solid Surface Top: Cambria Edinborough Top</p> <p>Solid Surface Edge Profile: Eased Edge</p> <p>Solid Surface Thickness: 2CM</p>		<p>HF Collection 465 Forbes Blvd South San Francisco , CA 94080 USA P 650-952-2546 F 650-952-2681 Contact Default</p> <p>Sarah Turner USA P 650-952-2546 F 650-952-2681 Contact Default</p>	* Please Refer to TBE Standard Construction Standards	
CG-12.H	<p>Desk RH - 48"W Description: Custom Cantilever Desk; Right-Hand;</p> <p>Finish: Stained To Match Aborite W-448 LQ</p> <p>Dimensions: 4'-0"W X 1'-7"D X 34"OAH</p> <p>Hardware: Similar to image provided</p> <p>Solid Surface Top: Cambria Edinborough Top</p> <p>Solid Surface Edge Profile: Eased Edge</p> <p>Solid Surface Thickness: 2CM</p>		<p>HF Collection 465 Forbes Blvd South San Francisco , CA 94080 USA P 650-952-2546 F 650-952-2681 Contact Default</p> <p>Sarah Turner USA P 650-952-2546 F 650-952-2681 Contact Default</p>	* Please Refer to TBE Standard Construction Standards	
CG-14.H	<p>TV Wall Panel Description: Custom TV Wall Panel</p> <p>Finish: Stained To Match Aborite W-448 LQ</p> <p>Dimensions: TBD, based on client's TV Specification</p> <p>Hardware: Provide wall mounted security brackets, TV supports and power connection</p>		<p>HF Collection 465 Forbes Blvd South San Francisco , CA 94080 USA P 650-952-2546 F 650-952-2681 Contact Default</p> <p>Sarah Turner USA P 650-952-2546 F 650-952-2681 Contact Default</p>	* Please Refer to TBE Standard Construction Standards	
CG-15.H	<p>Dining Table - 36" Diameter Description: Wood Column, Cast Iron Base, RCT Glides</p> <p>Model #: 69A5 Series Table Base</p> <p>Finish: WBF154 Black</p> <p>Dimensions: 36" table top</p> <p>Base: 22</p> <p>Top: Cambria - Berwyn</p> <p>Edge Profile: Eased Edge</p> <p>Top Thickness: 2CM</p> <p>Legs/Feet: Nylon Glides</p>		<p>Shelby Williams 810 West Hwy 25/70 Newport, TN 37821 USA P 800-873-3252 F 866-900-0938 Contact Default</p> <p>Don Karrer 339 Wind Grove St. Louis, MO 63122 USA P 314-749-8128 F 314-394-2330 Contact Default</p>	* Please Refer to TBE Standard Construction Standards	





Control #	Description	Area / Location	Mfr / Vendor	Special Instructions	Image
CG-17.H	<p>Double Queen Occasional Table Description: Custom Round Occasional Table with Metal Frame</p> <p>Finish: Metal TBD</p> <p>Dimensions: 24" Diameter x 24" Height</p> <p>Base: Nylon Glides</p> <p>Solid Surface Top and Bottom Shelf: Cambria Berwyn</p>		<p>D'Style 3451 Main Street, Suite 108, Chula Vista, CA 91911 USA P 619-662-0560 F 619-662-3388 Contact Default</p> <p>Cory Weber USA P 314-583-0548 Contact Default</p>	* Please Refer to TBE Standard Construction Standards	
CG-18.H	<p>Activity Table 30" Dia. Description: 30" Diameter Activity Table</p> <p>Finish: E-2 Silvertone</p> <p>Dimensions: 30" Diameter Table Top x 30" Overall Height</p> <p>Hardware:</p> <p>Top: Cambria - Berwyn</p> <p>Edge Profile: Eased Edge</p> <p>Top Thickness: 2 CM</p> <p>Legs/Feet: Nylon Glides</p>		<p>Kellex Seating 33390 Liberty Parkway North Ridgeville, OH 44039 USA P 440-327-4428 Contact Default</p> <p>Susan Faulhaber 715 Briar Fork Rd. Des Peres, MO 63131 USA P 314-909-7172 F 314-909-7173 Contact Default</p>	* Please Refer to TBE Standard Construction Standards	
CG-21.H	<p>Typical Guestroom Vanity Description: Freestanding Wood Vanity with Lower Shelf & Solid Surface Top</p> <p>Model #: TBD</p> <p>Frame Finish: Stain To Match Arborite W448 LQ</p> <p>Top : Cambria Berwyn</p> <p>Top Thickness: 2 CM</p> <p>Dimensions: 72"L X 24"D X 34"OH</p> <p>Hardware: 10"H Brushed Stainless Metal Ferrules on all 4 Legs</p> <p>Sink Style: Undermount</p> <p>Faucet Style: Single Hole</p>		<p>HF Collection 465 Forbes Blvd South San Francisco , CA 94080 USA P 650-952-2546 F 650-952-2681 Contact Default</p> <p>Sarah Turner USA P 650-952-2546 F 650-952-2681 Contact Default</p>	<p>* Please Refer to TBE Standard Construction Standards</p> <p>* All Lumber/Joinery/Hardware/Finishing to Comply with AWI Standards for Vanities in Damp Locations</p> <p>* Refer to Cutsheets on Client Approved Sink & Faucet for Cutout Dimensions</p>	
CG-22.H	<p>Hotel Tower Elevator Lobby Console Table Description: Andy Console Table</p> <p>Model #: ACD-3308-03</p> <p>Finish: Black on Oak</p> <p>Dimensions: 50"L X 20"W X 30"H</p>		<p>D'Style 3451 Main Street, Suite 108, Chula Vista, CA 91911 USA P 619-662-0560 F 619-662-3388 Contact Default</p> <p>Cory Weber USA P 314-583-0548 Contact Default</p>	* To be Ordered with Glass Top	
CG-23.H	<p>Suites Console Table Description: Waterfall Console</p> <p>Finish: Stained to Match Arborite W-448 LQ</p> <p>Dimensions: 1'-10"D X 5'-0"W X 30"H</p> <p>Solid Surface Top: Cambria Edinborough Top</p> <p>Solid Surface Edge Profile: Eased Edge</p> <p>Solid Surface Thickness: 2CM</p>		<p>HF Collection 465 Forbes Blvd South San Francisco , CA 94080 USA P 650-952-2546 F 650-952-2681 Contact Default</p> <p>Sarah Turner USA P 650-952-2546 F 650-952-2681 Contact Default</p>		

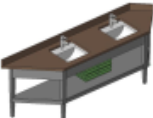

Control #	Description	Area / Location	Mfr / Vendor	Special Instructions	Image
CG-25.H	<p>Accessible Guestroom Vanity Item Name: Typical ADA Vanity</p> <p>Model #: TBD</p> <p>Description: Wall Mounted Vanity with Solid Surface & Wood Apron</p> <p>Apron Finish: Stain to Match Arborite W448 LQ</p> <p>Top: Cambria Berwyn</p> <p>Top Thickness: 2 CM</p> <p>Dimensions: 3'-3"W X 2'-0"D; 5"H Apron</p> <p>Sink Style: Undermount</p> <p>Faucet Style: Single Hole</p>		<p>HF Collection 465 Forbes Blvd South San Francisco , CA 94080 USA P 650-952-2546 F 650-952-2681 Contact Default</p> <p>Sarah Turner USA P 650-952-2546 F 650-952-2681 Contact Default</p>	<p>* Insulation Kits to Be Provided for P-Trap and Waterlines per Requirements for ADA Vanities</p> <p>* Please Refer to TBE Standard Construction Standards</p> <p>* All Lumber/Joinery/Hardware/Finishing to Comply with AWI Standards for Vanities in Damp Locations</p> <p>* Refer to Cutsheets on Client Approved Sink & Faucet for Cutout Dimensions</p>	
CG-26.H	<p>2 Room Suite Accessible Guestroom Vanity Item Name: ADA Vanity - Front & Side Apron</p> <p>Model #: TBD</p> <p>Description: Wall Mounted Vanity with Solid Surface & Wood Apron</p> <p>Apron Finish: Stain to Match Arborite W448 LQ</p> <p>Top: Cambria Berwyn</p> <p>Top Thickness: 2 CM</p> <p>Dimensions: 3'-3"W X 2'-0"D; 5"H Apron</p> <p>Sink Style: Undermount</p> <p>Faucet Style: Single Hole</p>		<p>HF Collection 465 Forbes Blvd South San Francisco , CA 94080 USA P 650-952-2546 F 650-952-2681 Contact Default</p> <p>Sarah Turner USA P 650-952-2546 F 650-952-2681 Contact Default</p>	<p>* Heavy Duty Wall Angle Support Must be Provided on Non-Wall Side</p> <p>* Insulation Kits to Be Provided for P-Trap and Waterlines per Requirements for ADA Vanities</p> <p>* Please Refer to TBE Standard Construction Standards</p> <p>* All Lumber/Joinery/Hardware/Finishing to Comply with AWI Standards for Vanities in Damp Locations</p> <p>* Refer to Cutsheets on Client Approved Sink & Faucet for Cutout Dimensions</p>	
CG-27.H	<p>Guestroom Vanity - 5' Description: Freestanding Wood Vanity with Lower Shelf & Solid Surface Top</p> <p>Model #: TBD</p> <p>Frame Finish: Stain To Match Arborite W448 LQ</p> <p>Top : Cambria Berwyn</p> <p>Top Thickness: 2 CM</p> <p>Dimensions: 60"L X 24"D X 34"OH</p> <p>Hardware: 10"H Brushed Stainless Metal Ferrules on all 4 Legs</p> <p>Sink Style: Undermount</p> <p>Faucet Style: Single Hole</p>		<p>HF Collection 465 Forbes Blvd South San Francisco , CA 94080 USA P 650-952-2546 F 650-952-2681 Contact Default</p> <p>Sarah Turner USA P 650-952-2546 F 650-952-2681 Contact Default</p>	<p>* Please Refer to TBE Standard Construction Standards</p> <p>* All Lumber/Joinery/Hardware/Finishing to Comply with AWI Standards for Vanities in Damp Locations</p> <p>* Refer to Cutsheets on Client Approved Sink & Faucet for Cutout Dimensions</p>	
CG-28.H	<p>2 Room Suites Vanity - Angled Top Description: Angled Freestanding Wood Vanity with Lower Shelf & Solid Surface Top</p> <p>Model #: TBD</p> <p>Frame Finish: Stain To Match Arborite W448 LQ</p> <p>Top : Cambria Berwyn</p> <p>Top Thickness: 2 CM</p> <p>Dimensions: SEE ARCHITECTURAL PLANS</p> <p>Hardware: 10"H Brushed Stainless Metal Ferrules on all 4 Legs</p> <p>Sink Style: Undermount</p> <p>Faucet Style: Single Hole</p>		<p>HF Collection 465 Forbes Blvd South San Francisco , CA 94080 USA P 650-952-2546 F 650-952-2681 Contact Default</p> <p>Sarah Turner USA P 650-952-2546 F 650-952-2681 Contact Default</p>	<p>* Please Refer to TBE Standard Construction Standards</p> <p>* All Lumber/Joinery/Hardware/Finishing to Comply with AWI Standards for Vanities in Damp Locations</p> <p>* Refer to Cutsheets on Client Approved Sink & Faucet for Cutout Dimensions</p>	

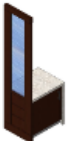
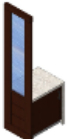



Control #	Description	Area / Location	Mfr / Vendor	Special Instructions	Image
CG-29.H	<p>2 Room Suites Powder Room Vanity Description: Freestanding Wood Vanity with Lower Shelf & Solid Surface Top</p> <p>Model #: TBD</p> <p>Frame Finish: Stain To Match Arborite W448 LQ</p> <p>Top : Cambria Berwyn</p> <p>Top Thickness: 2 CM</p> <p>Dimensions: 48"W X 24"D X 34" OAH</p> <p>Hardware: 10"H Brushed Stainless Metal Ferrules on all 4 Legs</p> <p>Sink Style: Undermount</p> <p>Faucet Style: Single Hole</p>		<p>HF Collection 465 Forbes Blvd South San Francisco , CA 94080 USA P 650-952-2546 F 650-952-2681 Contact Default</p> <p>Sarah Turner USA P 650-952-2546 F 650-952-2681 Contact Default</p>	<p>* Please Refer to TBE Standard Construction Standards</p> <p>* All Lumber/Joinery/Hardware/Finishing to Comply with AWI Standards for Vanities in Damp Locations</p> <p>* Refer to Cutsheets on Client Approved Sink & Faucet for Cutout Dimensions</p>	
CG-30.H	<p>Refrigerator Drybar with LH Panel Description: Freestanding Refrigerator Cabinet with Solid Surface Waterfall Side and LH Decorative Screen Panel</p> <p>Model #: TBD</p> <p>Cabinet & Panel Finish: Stain To Match Arborite W448 LQ</p> <p>Waterfall Top & Side : Cambria Berwyn</p> <p>Top Thickness: Varies - SEE SHOP DRAWINGS</p> <p>Acrylic Panel for Screen: Envel Rice Paper - Weekend Sky</p> <p>Dimensions: 2'-8"W X 8'-6"H X 2'-1/2"D; 2'-10"H to Top Counter</p> <p>Hardware: TBD</p>		<p>HF Collection 465 Forbes Blvd South San Francisco , CA 94080 USA P 650-952-2546 F 650-952-2681 Contact Default</p> <p>Sarah Turner USA P 650-952-2546 F 650-952-2681 Contact Default</p>	<p>* Please Refer to TBE Standard Construction Standards</p> <p>* All Lumber/Joinery/Hardware/Finishing to Comply with AWI Standards for Vanities in Damp Locations</p>	
CG-31.H	<p>Refrigerator Drybar with RH Panel Description: Freestanding Refrigerator Cabinet with Solid Surface Waterfall Side and RH Decorative Screen Panel</p> <p>Model #: TBD</p> <p>Cabinet & Panel Finish: Stain To Match Arborite W448 LQ</p> <p>Waterfall Top & Side : Cambria Berwyn</p> <p>Top Thickness: Varies - SEE SHOP DRAWINGS</p> <p>Acrylic Panel for Screen: Envel Rice Paper - Weekend Sky</p> <p>Dimensions: 2'-8"W X 8'-6"H X 2'-1/2"D; 2'-10"H to Top Counter</p> <p>Hardware: TBD</p>		<p>HF Collection 465 Forbes Blvd South San Francisco , CA 94080 USA P 650-952-2546 F 650-952-2681 Contact Default</p> <p>Sarah Turner USA P 650-952-2546 F 650-952-2681 Contact Default</p>	<p>* Please Refer to TBE Standard Construction Standards</p> <p>* All Lumber/Joinery/Hardware/Finishing to Comply with AWI Standards for Vanities in Damp Locations</p>	
CG-32.H	<p>Refrigerator Drybar with LH Waterfall - No Panel Description: Freestanding Refrigerator Cabinet with Solid Surface LH Waterfall</p> <p>Model #: TBD</p> <p>Cabinet & Panel Finish: Stain To Match Arborite W448 LQ</p> <p>Waterfall Top & Side : Cambria Berwyn</p> <p>Top Thickness: Varies - SEE SHOP DRAWINGS</p> <p>Dimensions: 2'-6"W X 2'-10"H X 2'-1/2"D</p> <p>Hardware: TBD</p>		<p>HF Collection 465 Forbes Blvd South San Francisco , CA 94080 USA P 650-952-2546 F 650-952-2681 Contact Default</p> <p>Sarah Turner USA P 650-952-2546 F 650-952-2681 Contact Default</p>	<p>* Please Refer to TBE Standard Construction Standards</p> <p>* All Lumber/Joinery/Hardware/Finishing to Comply with AWI Standards for Vanities in Damp Locations</p>	

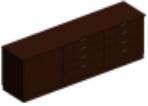



Control #	Description	Area / Location	Mfr / Vendor	Special Instructions	Image
CG-33.H	Refrigerator Drybar with RH Waterfall - No Panel Description: Freestanding Refrigerator Cabinet with Solid Surface RH Waterfall Model #: TBD Cabinet & Panel Finish: Stain To Match Arborite W448 LQ Waterfall Top & Side : Cambria Berwyn Top Thickness: Varies - SEE SHOP DRAWINGS Dimensions: 2'-6"W X 2'-10"H X 2'-1/2"D Hardware: TBD		HF Collection 465 Forbes Blvd South San Francisco , CA 94080 USA P 650-952-2546 F 650-952-2681 Contact Default Sarah Turner USA P 650-952-2546 F 650-952-2681 Contact Default	* Please Refer to TBE Standard Construction Standards * All Lumber/Joinery/Hardware/Finishing to Comply with AWI Standards for Vanities in Damp Locations	
CG-34.H	Refrigerator Drybar - No Waterfall or Panel Description: Freestanding Refrigerator Cabinet with Solid Surface RH Waterfall Model #: TBD Cabinet & Panel Finish: Stain To Match Arborite W448 LQ Waterfall Top & Side : Cambria Berwyn Top Thickness: Varies - SEE SHOP DRAWINGS Dimensions: 2'-1"W X 2'-1/2"D X 2'-10"H Hardware: TBD		HF Collection 465 Forbes Blvd South San Francisco , CA 94080 USA P 650-952-2546 F 650-952-2681 Contact Default Sarah Turner USA P 650-952-2546 F 650-952-2681 Contact Default	* Please Refer to TBE Standard Construction Standards * All Lumber/Joinery/Hardware/Finishing to Comply with AWI Standards for Vanities in Damp Locations	
CG-35.H	2 Room Suite Drybar Description: Drybar with Refrigerator Cabinet Model #: TBD Cabinet & Panel Finish: Stain To Match Arborite W448 LQ Top: Cambria Berwyn Top Thickness: 2 CM Dimensions: SEE ARCHITECTURAL DRAWINGS Hardware: TBD		HF Collection 465 Forbes Blvd South San Francisco , CA 94080 USA P 650-952-2546 F 650-952-2681 Contact Default Sarah Turner USA P 650-952-2546 F 650-952-2681 Contact Default	* Please Refer to TBE Standard Construction Standards * All Lumber/Joinery/Hardware/Finishing to Comply with AWI Standards for Vanities in Damp Locations	
CG-36.H	ADA 2 Room Suite Drybar Description: Drybar with Refrigerator Cabinet Model #: TBD Cabinet & Panel Finish: Stain To Match Arborite W448 LQ Top: Cambria Berwyn Top Thickness: 2 CM Dimensions: SEE ARCHITECTURAL DRAWINGS Hardware: TBD		HF Collection 465 Forbes Blvd South San Francisco , CA 94080 USA P 650-952-2546 F 650-952-2681 Contact Default Sarah Turner USA P 650-952-2546 F 650-952-2681 Contact Default	* Please Refer to TBE Standard Construction Standards * All Lumber/Joinery/Hardware/Finishing to Comply with AWI Standards for Vanities in Damp Locations	
CG-37.H	Extended King Dresser/Drybar Combo Description: Custom Six Drawer Dresser/Drybar Combo Finish: Stained To Match Arborite W-448 LQ Dimensions: 8'-8"W X 2'-1/2"D X 34"OAH Hardware: Similar to image provided Drawer Safe: SAFEMARK SYSTEMS DNX 5.4 Solid Surface Top: Cambria Edinburgh Top Solid Surface Edge Profile: Eased Edge Solid Surface Thickness: 2CM		HF Collection 465 Forbes Blvd South San Francisco , CA 94080 USA P 650-952-2546 F 650-952-2681 Contact Default Sarah Turner USA P 650-952-2546 F 650-952-2681 Contact Default	* Please Refer to TBE Standard Construction Standards	

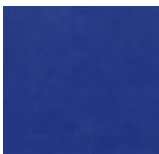



Control #	Description	Area / Location	Mfr / Vendor	Special Instructions	Image
CG-38.H	<p>2 Room Suite TV Console Description: Console Below TV in @ Room Suite</p> <p>Finish: Stained To Match Arborite W-448 LQ</p> <p>Dimensions: 6'-0"W X 0'-8"D X 2'-4"OAH</p> <p>Solid Surface Top: Cambria Edinborough Top</p> <p>Solid Surface Edge Profile: Eased Edge</p> <p>Solid Surface Thickness: 2CM</p>		<p>HF Collection 465 Forbes Blvd South San Francisco , CA 94080 USA P 650-952-2546 F 650-952-2681 Contact Default</p> <p>Sarah Turner USA P 650-952-2546 F 650-952-2681 Contact Default</p>	* Please Refer to TBE Standard Construction Standards	
CG-39.H	<p>Desk - 48"W Extended King Description: Custom Cantilevered Desk</p> <p>Finish: Stained To Match Aborite W-448 LQ</p> <p>Dimensions: 4'-0"W X 2'-1/2"D X 2'-6"OAH</p> <p>Hardware: Similar to image provided</p> <p>Solid Surface Top: Cambria Edinborough Top</p> <p>Solid Surface Edge Profile: Eased Edge</p> <p>Solid Surface Thickness: 2CM</p>		<p>HF Collection 465 Forbes Blvd South San Francisco , CA 94080 USA P 650-952-2546 F 650-952-2681 Contact Default</p> <p>Sarah Turner USA P 650-952-2546 F 650-952-2681 Contact Default</p>	* Please Refer to TBE Standard Construction Standards	
Upholstery					
F-1.H	<p>King Headboard Fabric Pattern: Custom Silica</p> <p>Model #: ML5442-A2</p> <p>Color: Custom</p> <p>Content: 100% Silicone</p> <p>Backing: Polyester</p> <p>Repeat: N/A</p> <p>Width: 54"</p> <p>Shown Railroaded: No</p> <p>Finish: N/A</p> <p>Cleaning Code: WS; Bleach Cleanable (4:1)</p> <p>Abrasion: 365,000 Double Rubs</p> <p>Flammability: CA Bulletin 117 Sec. E</p>		<p>Momentum 17811 Fitch Irvine, CA 92614 USA P 800.366.6839 F 949.833.9233 Contact Michele Land</p> <p>Michele Land USA Contact Default</p>		
F-2.H	<p>Queen Headboard Fabric Pattern: Custom Silica</p> <p>Model #: ML5442-A2</p> <p>Color: Custom</p> <p>Content: 100% Silicone</p> <p>Backing: Polyester</p> <p>Repeat: N/A</p> <p>Width: 54"</p> <p>Shown Railroaded: No</p> <p>Finish: N/A</p> <p>Cleaning Code: WS; Bleach Cleanable (4:1)</p> <p>Abrasion: 365,000 Double Rubs</p> <p>Flammability: CA Bulletin 117 Sec. E</p>		<p>Momentum 17811 Fitch Irvine, CA 92614 USA P 800.366.6839 F 949.833.9233 Contact Michele Land</p> <p>Michele Land USA Contact Default</p>	* Designer to approve strike off sample before order is placed.	



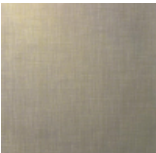

Control #	Description	Area / Location	Mfr / Vendor	Special Instructions	Image
F-3.H	<p>Fabric for Lounge Chair Fronts Pattern: Millenium</p> <p>Product Number: 09143011</p> <p>Color: Sapphire</p> <p>Content: 85% Post consumer Recycled Polyester, 15% Polyester</p> <p>Repeat: 1/8"L, 1/8"W</p> <p>Shown Railroaded: No</p> <p>Finish: Soil & Stain Resistant</p> <p>Cleaning Code: WS</p> <p>Durability: 200,000 D.R.</p> <p>Flammability: CA Bulletin 117 2013</p> <p>Dye: Piece</p> <p>Backing: Acrylic</p> <p>Weight: 0.82 lb.</p> <p>Fabric Grade:</p>		<p>Momentum 17811 Fitch Irvine, CA 92614 USA P 800.366.6839 F 949.833.9233 Contact Michele Land</p> <p>Michele Land USA Contact Default</p>		
F-6.H	<p>Fabric for Guestroom Lounge Chair Backs Pattern: Abstract Plaid</p> <p>Model #: 230087</p> <p>Color: Cobalt</p> <p>Content: 42% Post Consumer Polyester, 37% Polyester, 21% Nylon</p> <p>Repeat: Vertical: 4", Horizontal: 9"</p> <p>Width: 55"</p> <p>Railroaded: N/A</p> <p>Finish: Teflon</p> <p>Cleaning Code: Pure Solvents Dry Cleaning</p> <p>Abrasion: 50,000 Double Rubs</p> <p>Flammability: CAL 117, NFPA 260, UFAC I</p> <p>Fabric Grade: 06</p>		<p>Robert Allen Group 2 Hampshire Street, Suite 300 Foxboro, MA 02035 USA P 800-333-3777 F 800-332-8256 Contact Default</p> <p>Kim Caldwell KDR Designer Showrooms Saint Louis, MO 63146 USA P 314-792-0706 F 314-993-6551 Contact Default</p>		
F-7.H	<p>Fabric for Back of Dining Chair Pattern: Abstract Plaid</p> <p>SKU: 230087</p> <p>Color: Cobalt</p> <p>Content: 42% Post Consumer Polyester, 37% Polyester, 21% Nylon</p> <p>Repeat: Horizontal 9, Vertical 4</p> <p>Width: 55"</p> <p>Flammability: CA 117 2013</p> <p>Repeat Direction: Up the Roll</p> <p>Fabric Grade: 06</p>		<p>Robert Allen Group 2 Hampshire Street, Suite 300 Foxboro, MA 02035 USA P 800-333-3777 F 800-332-8256 Contact Default</p> <p>Kim Caldwell KDR Designer Showrooms Saint Louis, MO 63146 USA P 314-792-0706 F 314-993-6551 Contact Default</p>		



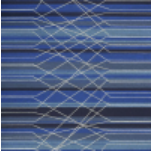
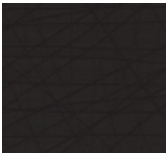

Control #	Description	Area / Location	Mfr / Vendor	Special Instructions	Image
F-9.H	<p>Fabric For Desk Chair Pattern: Silica</p> <p>Model #: 09126621</p> <p>Color: Sketch</p> <p>Content: 100% Silicone</p> <p>Backing: Polyester</p> <p>Repeat: NA</p> <p>Width: 54"</p> <p>Railroaded: No</p> <p>Weight: 1.60 lb</p> <p>Finish: -</p> <p>Maintenance: WS- Water-Based Cleaning Agents or Foam; Bleach Cleanable</p> <p>Abrasion: 365,000 D.R.</p> <p>Flammability: CA Bulletin 117 2013; UFAC Class 1; NFPA 260 Class 1</p>		<p>Momentum 17811 Fitch Irvine, CA 92614 USA P 800.366.6839 F 949.833.9233 Contact Michele Land</p> <p>Michele Land USA Contact Default</p>		
F-11.H	<p>Fabric for Suites Lounge Chair, Dining Chair Seat, Ottomans, & Luggage Benches Pattern: Dante</p> <p>Model #: UHP-DT-03</p> <p>Color: Sateen</p> <p>Content: 45% Polyurethane (face), 55% Polyester (back)</p> <p>Repeat: N/A</p> <p>Width: 54"</p> <p>Finish: Graffiti-Free</p> <p>Cleaning Code: W (water-based cleaners)</p> <p>Abrasion: 100,000 Double Rubs</p> <p>Flammability: Passes CAL TB 117-2013 and UFAC/NFPA 260</p> <p>Lightfastness:</p> <p>Seam Slippage: ASTM D1683 Seam Strength: meets requirements</p> <p>Breaking Strength: ASTM D2261: meets requirements</p> <p>Hydrolysis Resistance: 10 Weeks</p> <p>Sustainability: Oeko-Tex Standard 100</p>		<p>D.L. Couch 499 E. County Road 300 South New Castle, IN 47362 USA P 800.433.0790 F 800.882.6824 Contact Melissa Biethman C 314.809.7730</p> <p>Melissa Biethman 499 E. County RD 300 S. P.O. Box 570 New Castle, IN 47362 USA P 314-809-7730 F 800-882-6824</p>		
F-12.H	<p>Fabric For Sofa Sleeper Pattern: Hashtag</p> <p>Model #: 3662-803</p> <p>Color: Chalkboard</p> <p>Content: 47% Acrylic, 53% Polyester</p> <p>Backing: Acrylic</p> <p>Width: 54"</p> <p>Shown Railroaded: No</p> <p>Weight: 18 oz/ly</p> <p>Finish: Stain Repellent</p> <p>Cleaning Code: Water-based/Solvent (WS)</p> <p>Abrasion: 80,000 Double Rubs</p> <p>Flammability: CA TB 117-2013 , NFPA 260</p> <p>Lightfastness: 40 hours</p>		<p>DesignTex</p> <p>P 800.221.1540 Contact Glenda Jehle C 314.922.6590</p> <p>Glenda Jehle 4731 McPherson Saint Louis, MO 63108 USA P 314-863-2228 F 303-722-7703 Contact Default</p>		



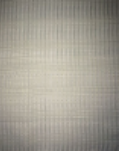

Control #	Description	Area / Location	Mfr / Vendor	Special Instructions	Image
F-13.H	<p>Fabric For Pillow Sofas Sleepers Pattern: Prizm</p> <p>Model #: PR-45</p> <p>Color: Pipeline</p> <p>Content: 65% Rayon, 35% Recycled Solution Dyed Nylon</p> <p>Backing: Light Acrylic</p> <p>Repeat: 14.2"H X 12"V</p> <p>Width: 54"</p> <p>Railroad: No</p> <p>Finish: Incase</p> <p>Cleaning Code: S</p> <p>Abrasion: 50,000+ DR</p> <p>Flammability: California Technical Bulletin 117: 2013</p>		<p>Paul Brayton Designs 403 Interstate Drive Archdale, NC 27263 USA P 336.882-5200 Contact Default</p> <p>Liz Buhr and Company USA P 314-412-2120 F 847-657-7641 Contact Default</p>		
F-15.H	<p>Fabric For Sofa Sleeper Ottomans Pattern: Rove</p> <p>Model #: 3630-804</p> <p>Color: Midnight</p> <p>Content: 100% Vinyl</p> <p>Backing: Cotton, Woven</p> <p>Repeat: Vertical: 14.3" x Horizontal: 18"</p> <p>Width: 59"</p> <p>Shown Railroaded: No</p> <p>Weight: 41.3 oz/ly</p> <p>Cleaning Code: W, Bleach Cleanable (10:1)</p> <p>Abrasion: 100,000 Wyzenbeek</p> <p>Flammability: CA TB 117-2013 , NFPA 260</p> <p>Lightfastness: 40 hours</p>		<p>Designtex</p> <p>P 800.221.1540 Contact Glenda Jehle C 314.922.6590</p> <p>Glenda Jehle 4731 McPherson Saint Louis, MO 63108 USA P 314-863-2228 F 303-722-7703 Contact Default</p>		
F-21.H	<p>Overdrape Face Fabric Pattern: Santiago FR</p> <p>Color: Indigo</p> <p>Content: 100% FR- Polyester</p> <p>Repeat: 13.4"Vert.; 13.5"Horz.</p> <p>Width: 54"</p> <p>Railroad: No</p> <p>Cleaning Code: Washable</p> <p>Flammability: Passes NFPA 701</p>		<p>Fabricut 9303 East 46th Street Tulsa, OK 74145 USA P 800.999.5533 Contact Karma Lamping C 314.315.6732</p> <p>Karma Lamping USA Contact Default</p>		
F-22.H	Overdrape Liner Fabric				







Control #	Description	Area / Location	Mfr / Vendor	Special Instructions	Image
F-23.H	<p>Sheer Fabric Pattern: Concerto</p> <p>Color: Ivory</p> <p>Content: 100% Polyester</p> <p>Repeat: .7"Vert; .1"Horz.</p> <p>Width: 116"</p> <p>Double Rubs: None</p> <p>Railroad: Yes</p> <p>Finish: None</p> <p>Cleaning Code: S</p> <p>Flammability: Passes NFPA 701</p>		<p>Fabricut 9303 East 46th Street Tulsa, OK 74145 USA P 800.999.5533 Contact Karma Lamping C 314.315.6732</p> <p>Karma Lamping USA Contact Default</p>		
F-24.H	<p>Fabric for Scarf Trim & Backing Pattern: Prestige</p> <p>Color: L Sapphire</p> <p>Content: 100% Polyester</p> <p>Backing: None</p> <p>Repeat: None</p> <p>Width: 54.00 in.</p> <p>Railroad: Not railroaded</p> <p>Finish: None</p> <p>Cleaning Code: S</p> <p>Double Rubs: 100,000 Double Rubs</p> <p>Fire Codes: Passes "NFPA 701" 2010</p>		<p>Fabricut 9303 East 46th Street Tulsa, OK 74145 USA P 800.999.5533 Contact Karma Lamping C 314.315.6732</p> <p>Karma Lamping USA Contact Default</p>		
Lighting					
L-1.H	<p>Desk Lamp Description: Table Lamp</p> <p>Model #: 6276EO</p> <p>Lamp Dimensions: 30"H</p> <p>Lamp Finish: Brushed Nickel</p> <p>Switch: On/Off rocker switch at base</p> <p>Bulb Wattage: Recommend 27 watt CFL or 11 watt LED bulb</p> <p>Cordset: 8' 3-prong grounded cordset</p> <p>Socket: Medium Base</p> <p>Base: 6.5"W, 6.5"D</p> <p>Shade Part Number: 1616105LWNI</p> <p>Shade Material: White Linen</p> <p>Shade Dimensions: 16"x16"x10.5"</p> <p>Harp: NA</p> <p>Added Feature: Reference special instructions for additional instructions to be included in lamp</p>		<p>Arkansas Lighting 1701 South 28th Van Buren, AR 72956 USA P 479-474-0876 F 479-474-9007 Contact Default</p> <p>Maria Neri 1701 South 28th Van Buren, AR 72956 USA P 479-474-0876 F 479-474-9007 Contact Default</p>	<p>* UL Listed</p> <p>* To be included in lamp: 2 convenience outlets, 2 USB ports</p>	







Control #	Description	Area / Location	Mfr / Vendor	Special Instructions	Image
L-2.H	<p>Floor Lamp Description: Floor Lamp Model #: 6209FPC Lamp Dimensions: 64"H Lamp Finish: Metallic Silver Switch: On/Off push through socket switch Bulb Wattage: Recommend 32 or 27 watt CFL bulb Cordset: 11' usable SPT-2 power supply cord with polarized plug Socket: Medium Base Base: 11"W,11"D Shade Part Number: 1414120PR Shade Material : White Linen Shade Dimensions: 14"x14"x14"x14"x12" Harp: 10"</p>		<p>Arkansas Lighting 1701 South 28th Van Buren, AR 72956 USA P 479-474-0876 F 479-474-9007 Contact Default</p> <p>Maria Neri 1701 South 28th Van Buren, AR 72956 USA P 479-474-0876 F 479-474-9007 Contact Default</p>	* UL Listed	
L-3.H	<p>Double Queen Table Lamp Description: Table Lamp with 3-way, 4 position push button base switch Model #: 5688E20-S Frame Finish: Espresso/Brushed Nickel Shade Finish: White Linen Shade Dimensions: Shade Top: 8" x 15", Shade Bottom: 8" x 15", Shade Depth: 10" Volts / Wattage: Two 19 Watt CFL or 10 Watt LED Bulbs Cord Length: 8' 45° 3-prong grounded cordset Cord Color:</p>		<p>Arkansas Lighting 1701 South 28th Van Buren, AR 72956 USA P 479-474-0876 F 479-474-9007 Contact Default</p> <p>Maria Neri 1701 South 28th Van Buren, AR 72956 USA P 479-474-0876 F 479-474-9007 Contact Default</p>	* UL Listed	
L-4.H	<p>Suites End Table Lamp Description: Table Lamp Model #: 6277EO-USB Lamp Dimensions: 31"H Lamp Finish: Brushed Nickel and Silver Wood Switch: On/Off rocker base switch Bulb Wattage: Recommend 27 watt CFL or 11 watt LED bulb Cordset: 8' 45 degree angle 3-prong grounded cordset Socket: Medium Base Base: 9"W, 6"D Shade Part Number: 0909115RLWNI Shade Material: White Linen Shade Dimensions: 9"x16"x9"x19"x11.5" Harp: 10" Miscellaneous: With one convenience outlet and one USB port</p>		<p>Arkansas Lighting 1701 South 28th Van Buren, AR 72956 USA P 479-474-0876 F 479-474-9007 Contact Default</p> <p>Maria Neri 1701 South 28th Van Buren, AR 72956 USA P 479-474-0876 F 479-474-9007 Contact Default</p>	* UL Listed	
Fixed Lighting					





Control #	Description	Area / Location	Mfr / Vendor	Special Instructions	Image
FL-1.H	<p>King Nightstand Wall Sconce Description: Ensu Wall Canopy with Chill Pendant in Blue</p> <p>Model #:</p> <p>Canopy Finish: Matte Black</p> <p>Canopy Dimensions: 4.75"W x 5.25"H x 4.5"D</p> <p>Voltage/Wattage: 120v in/12v LED out</p> <p>Lamping: LED</p> <p>Pendant Name: Chill</p> <p>Pendant Color: Blue</p> <p>Pendant Model #: HS583</p> <p>Pendant Finish: Satin Nickel</p> <p>Pendant Lamping: 1B GY6 .35 Xenon 50w</p> <p>Mount: FSJ Fusion Jack</p>		<p>Lighting Associates 3216 South Brentwood Blvd. Webster Groves, MO 63119 USA P 314-531-3500 F 314-531-3737 Contact Default</p> <p>Callia Ball 3216 S Brentwood Blvd Webster Groves, MO 63119 USA P 314-406-9946 Contact Default</p>		
FL-2.H	<p>Double Queen Nightstand Wall Sconce Description: Ensu Wall Canopy with Chill Pendant in Blue</p> <p>Model #:</p> <p>Finish: Matte Black</p> <p>Dimensions:</p> <p>Voltage/Wattage: 120v in/12v LED out</p> <p>Lamping: LED</p> <p>Pendant Name: Chill</p> <p>Pendant Color:</p> <p>Pendant Model #: HS583</p> <p>Pendant Finish: Satin Nickel</p> <p>Pendant Lamping: 1B GY6 .35 Xenon 50w</p> <p>Mount: FSJ Fusion Jack</p>		<p>Lighting Associates 3216 South Brentwood Blvd. Webster Groves, MO 63119 USA P 314-531-3500 F 314-531-3737 Contact Default</p>		
FL-3.H	<p>Reading Lamp at Nightstand Description: LED Headboard Reading Light</p> <p>Model #: 6394S-LED</p> <p>Finish: Brushed Nickel</p> <p>Dimensions: 6-3/4"W</p> <p>Voltage/Wattage: 2700K</p> <p>Lamping:</p> <p>Power Cord: 8 foot</p> <p>Power Cord Color: Black</p> <p>Switching: Switches off when arm is closed, turns on when arm is opened</p>		<p>Arkansas Lighting 1701 South 28th Van Buren, AR 72956 USA P 479-474-0876 F 479-474-9007 Contact Default</p> <p>Maria Neri 1701 South 28th Van Buren, AR 72956 USA P 479-474-0876 F 479-474-9007 Contact Default</p>		
FL-4.H	<p>Wall Sconce At Entry Door Description: Wall Sconce</p> <p>Model #: 3910 C</p> <p>Finish: Matte Black</p> <p>Overall Height: 24"</p> <p>Voltage/Wattage: GU24 Socket</p> <p>Lamping: 26 watt PL style bulb with GU24 Base</p> <p>Wired: Direct</p> <p>Shade Color: White Acrylic Shade</p> <p>Stem Support & Screw Covers: To be matte gold metal finish</p>		<p>Arkansas Lighting 1701 South 28th Van Buren, AR 72956 USA P 479-474-0876 F 479-474-9007 Contact Default</p> <p>Maria Neri 1701 South 28th Van Buren, AR 72956 USA P 479-474-0876 F 479-474-9007 Contact Default</p>		



Control #	Description	Area / Location	Mfr / Vendor	Special Instructions	Image
FL-5.H	<p>Ceiling Fixture at Door Drops Description: Custom 34" Diameter Drum Pendant</p> <p>Model #: P53408-F6-D868-3/18.9W LED -UNV-STM2-DIM</p> <p>Finish: Powder Coat Brass</p> <p>Lens Finish: Etched White; Top and Bottom Lens</p> <p>Dimensions: 34"Dia. X 8"Deep</p> <p>Stem Length: 2'</p> <p>Light Source: Qty.3 18.9W 3,000K Xiacato LEDs; Universal; 0-10V; Dimmable</p>		<p>Lumetta Inc. 33 Minnesota Ave. Warwick, RI 02888 USA P 401-691-3994 F 401-921-1310 Contact Default</p> <p>Saint Louis Lighting Group 7414 Manchester Road St. Louis, Mo. 63143 USA P 314-963-3311 Contact Default</p>		
FL-6.H	<p>Electric Mirror Description: Typical Guestroom Electric Vanity Mirror</p> <p>Model #: Integrity</p> <p>Dimensions: 72"W X 42"H X 3"D</p> <p>Voltage/Wattage: 114</p> <p>Lamping: LED</p>		<p>Electric Mirror 6101 Associated Blvd Suite 101 Everett, WA 98204 USA P 425-776-4946 F 425-491-8200 Contact Default</p>		
Miscellaneous					
M-1	<p>Drawer Safe for Dressers Description: DNX 5.4</p> <p>Dimensions: 19.75"W x 3.38"H x 13.75"D / Door Opening: 18.25"W, 75 degree maximum opening angle</p> <p>Color:</p> <p>Features: 4 Digit User Code, Illuminated ADA-Compliant Keypad, Enhanced LED Display, Audio Visual Operating Signals, 240 Event Audit Trail, Low Battery Indicator, Self-Diagnostic System, Motorized Locking System, Dual Hydraulic Arm Assist, Internal Light</p>		<p>Safemark Systems 2101 Park Center Drive Suite 125 Orlando, Florida USA P 1-800-255-8818 Contact Default</p>		
Bedding					
B-4.H	<p>Guestroom Throw for Bed Description: Santiago FR One Indigo</p> <p>Content: 100% FR-Polyester</p> <p>Application: Fabric</p> <p>Width: 54"</p> <p>Colors: Blue, Light Blue, Off White</p> <p>Vertical Repeat: 13.40"</p> <p>Horizontal Repeat: 13.50"</p> <p>Scale: Large</p> <p>Railroaded: Not railroaded</p> <p>Fire Codes: OEKO TEX STANDARD 100&#x0D; UFAC CLASS I/NFPA 260A&#x0D; PASSES "NFPA 701" 2010&#x0D; BOSTON FIRE TEST BFD&#x0D; IMO A 471</p> <p>Finish/Backing: None</p> <p>Collection: FR-One Collection 10-2014</p> <p>Double Rubs: Not available</p> <p>Cleaning Codes: None</p> <p>Trim: Fabricut: Pattern-Prestige/ Color-Sapphire</p>		<p>Fabricut 9303 East 46th Street Tulsa, OK 74145 USA P 800.999.5533 Contact Karma Lamping C 314.315.6732</p> <p>Karma Lamping USA Contact Default</p>		



Control #	Description	Area / Location	Mfr / Vendor	Special Instructions	Image
Mirror					
MR-1.H	Tall Mirror for Guestrooms Frame: 3"Width Finish: Antique Silver Dimensions: 2'-2"W X 5'-0"H				
MR-3.H	Desk Mirror Description: Mirror at Desk Model #: 2433-P Dimensions: 36" Diameter Finish: Polished Pewter Frame: Metallic Ribbed		Majestic Mirror and Frame 7425 NW 79th St. Miami, FL 33166 USA P 305-827-2661 F 305-827-2663 Contact Default		
Drapery					
DR-1.H	Guestroom Overdrape			<p>* DESCRIPTION: CENTER DRAW DRAPERY AND SHEER FABRICATION&#x0D; OVERDRAPE AND SHEER PLEAT STYLE: PINCH PLEAT&#x0D; LINING FOR OVERDRAPE: TO BE LINED WITH BLACKOUT LINER FABRIC&#x0D; FULLNESS: 200% (2 TO 1 FULLNESS) INCLUDING SPECIFIED OVERLAPS AND RETURNS. &#x0D; &#x0D; PLEATS: TRIPLE-FOLD PINCH PLEATS ARE BAR TACKED 1/2" UP FROM THE BOTTOM&#x0D; BUCKRUM. ALL PLEATS ARE EVENLY SPACED ACROSS THE TOP OF THE DRAPE.&#x0D; &#x0D; SEAMS: ALL SEAMS ARE OVERLOCKED, SAFETY STITCHED AND HIDDEN. SEAMS ARE PLACED SO THAT &#x0D; THEY DO NOT SHOW BETWEEN PLEATS AND NO MORE THAN 1/4" FROM SIDE OF PLEAT. THEY ARE PRESSED&#x0D; AND BLOCKED TO AVOID PUCKERING. PATTERNS ARE TO BE PATTERN MATCHED AT SEAMS, IF APPLICABLE.&#x0D; &#x0D; HEMS: THE BOTTOM HEM IS BLINDSTITCHED WITH A 4" DOUBLE TURN. THE SIDE HEMS ARE BLINDSTITCHED WITH A &#x0D; 1-1/2" DOUBLE TURN. COLOR MATCHED THREAD IS TO BE USED ON ALL TREATMENTS. ALL HEMS ARE PRESSED.&#x0D; SO THAT THERE IS NO PUCKERING AT THE STITCH LINE. PROVIDE 3/4" SQUARE HIDDEN SEWN-IN WEIGHTS AT EACH&#x0D; CORNER OF THE HEM FOR ADDED STABILITY. CORNERS SEWN CLOSED AT THE HEM USING A BONIS MACHINE.&#x0D; BEDCHAIN (SHOT-TAPED) IS SEWN INTO BOTTOM OF SHEER HEM FOR CONTINUOUS WEIGHT.&#x0D; &#x0D; HARDWARE&#x0D; PIN HOOKS: PROVIDE HEAVY DUTY, NON-RUSTING, STAINLESS STEEL PIN HOOKS&#x0D; DRAPERY WAND: 36" CLEAR BATON FOR TYPICAL GUESTROOMS AND SUITES; &#x0D; ACCESSIBLE (ADA) GUESTROOMS AND SUITES TO HAVE 48" CLEAR BATON&#x0D; &#x0D; HARDWARE SYSTEM&#x0D; 2 TRACK SYSTEM: CEILING MOUNTED&#x0D; CONSTRUCTION: &#x0D; DRAPERY LENGTH TO BE FLOOR TO CEILING&#x0D; CLEARANCE SPACE BETWEEN BOTTOM OF DRAPE AND FLOOR = 1"&#x0D; ALL HARDWARE INCLUDING TRACK SYSTEM TO BE PROVIDED BY THE MANUFACTURER&#x0D; &#x0D; LABELING: EACH DRAPE WILL HAVE A LABEL SEWN IN AN INCONSPICUOUS PLACE WITH SIZE &#x0D; AND ROOM NUMBER CLEARLY MARKED&#x0D;</p>	



Control #	Description	Area / Location	Mfr / Vendor	Special Instructions	Image
DR-2.H	Guestroom Sheer		<p>Fabricut 9303 East 46th Street Tulsa, OK 74145 USA P 800.999.5533 Contact Karma Lamping C 314.315.6732</p> <p>Karma Lamping USA Contact Default</p>	<p>* DESCRIPTION: CENTER DRAW DRAPERY AND SHEER FABRICATION&#x0D; OVERDRAPE AND SHEER PLEAT STYLE: PINCH PLEAT&#x0D; LINING FOR OVERDRAPE: TO BE LINED WITH BLACKOUT LINER FABRIC&#x0D; FULLNESS: 200% (2 TO 1 FULLNESS) INCLUDING SPECIFIED OVERLAPS AND RETURNS. &#x0D; &#x0D; PLEATS: TRIPLE-FOLD PINCH PLEATS ARE BAR TACKED 1/2" UP FROM THE BOTTOM&#x0D; BUCKRUM. ALL PLEATS ARE EVENLY SPACED ACROSS THE TOP OF THE DRAPE.&#x0D; &#x0D; SEAMS: ALL SEAMS ARE OVERLOCKED, SAFETY STITCHED AND HIDDEN. SEAMS ARE PLACED SO THAT &#x0D; THEY DO NOT SHOW BETWEEN PLEATS AND NO MORE THAN 1/4" FROM SIDE OF PLEAT. THEY ARE PRESSED&#x0D; AND BLOCKED TO AVOID PUCKERING. PATTERNS ARE TO BE PATTERN MATCHED AT SEAMS, IF APPLICABLE.&#x0D; &#x0D; HEMS: THE BOTTOM HEM IS BLINDSTITCHED WITH A 4" DOUBLE TURN. THE SIDE HEMS ARE BLINDSTITCHED WITH A &#x0D; 1-1/2" DOUBLE TURN. COLOR MATCHED THREAD IS TO BE USED ON ALL TREATMENTS. ALL HEMS ARE PRESSED &#x0D; SO THAT THERE IS NO PUCKERING AT THE STITCH LINE. PROVIDE 3/4" SQUARE HIDDEN SEWN-IN WEIGHTS AT EACH&#x0D; CORNER OF THE HEM FOR ADDED STABILITY. CORNERS SEWN CLOSED AT THE HEM USING A BONIS MACHINE.&#x0D; BEDCHAIN (SHOT-TAPED) IS SEWN INTO BOTTOM OF SHEER HEM FOR CONTINUOUS WEIGHT.&#x0D; &#x0D; HARDWARE&#x0D; PIN HOOKS: PROVIDE HEAVY DUTY, NON-RUSTING, STAINLESS STEEL PIN HOOKS&#x0D; DRAPERY WAND: 36" CLEAR BATON FOR TYPICAL GUESTROOMS AND SUITES; &#x0D; ACCESSIBLE (ADA) GUESTROOMS AND SUITES TO HAVE 48" CLEAR BATON&#x0D; &#x0D; HARDWARE SYSTEM&#x0D; 2 TRACK SYSTEM: CEILING MOUNTED&#x0D; CONSTRUCTION: &#x0D; DRAPERY LENGTH TO BE FLOOR TO CEILING&#x0D; CLEARANCE SPACE BETWEEN BOTTOM OF DRAPE AND FLOOR = 1"&#x0D; ALL HARDWARE INCLUDING TRACK SYSTEM TO BE PROVIDED BY THE MANUFACTURER&#x0D; &#x0D; LABELING: EACH DRAPE WILL HAVE A LABEL SEWN IN AN INCONSPICUOUS PLACE WITH SIZE &#x0D; AND ROOM NUMBER CLEARLY MARKED&#x0D;</p>	
DR-3.H	Corner King Suite Drapery				
DR-4.H	Corner King Suite Sheer				



Control #	Description	Area / Location	Mfr / Vendor	Special Instructions	Image
DR-5	<p>Mobility Guestroom Motorized Drapery Hardware Description: Lutron Motorized Drapery Hardware System</p> <p>Tracks Required: 1 Track Run for Lined Overdrape; 1 Track Run for Separate Sheer</p> <p>Pleat Style: Pinch Pleat</p> <p>Track Style: Straight Track</p> <p>Draw Style: Center Draw</p> <p>Drive Style: D175 Drive - Carries up to 175 lbs up to 18' in Length</p> <p>Power Panel: Lutron Wall Mount Four Button seeTouch Keypad</p> <p>: Open/Close Buttons Required for Overdrape</p> <p>: Open/Close Buttons Required for Separate Sheer</p> <p>Power Panel Color: (WH) White</p>		<p>Lutron Electronics Co., Inc. 7200 Suter Road Coppersburg, PA 18036-1299 USA P 1-610-282-3800 Contact Default</p>		

Seating



Item Report By Item Type

Project:

Project #: 609

Issue Date: 03 FEB 2017

ItemType: Seating

Control #	Item Name	Total Qty	Unit	Item Cost	Total Cost	Revision Date
CH-1.H	Typical King Guestroom Lounge Chair	0	Each			
CH-3.H	Ottoman at Lounge Chair	0	Each			
CH-5.H	Lounge Chair - Double Queen Rooms	90	Each			
CH-6.H	Dining Chair	150				
CH-7.H	Desk Chair	0	Each			
CH-8.H	Luggage Bench - with Back	60	Each			
CH-9.H	Luggage Bench - without back	0	Each			
CH-10.H	Suites Lounge Chair	0	Each			
CH-11.H	Queen Sofa Sleeper	33	Each			
CH-14.H	Pillow For Sofa Sleepers	2	Each			
CH-15.H	Ottoman at Sofa Sleepers	0				

CH-1.H



CH-3.H



CH-5.H

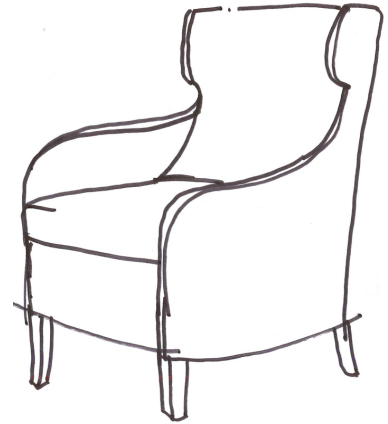

CH-6.H



CH-7.H



CH-8.H



CH-9.H



CH-10.H



CH-11.H





Image Report By Item Type

Project:

Project #: 609

Issue Date: 03 FEB 2017

Item Type: Seating

CH-14.H

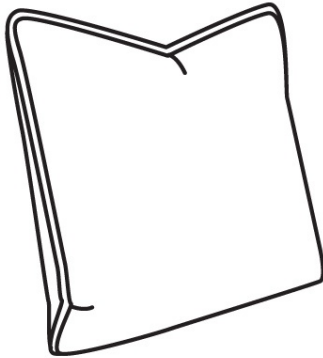

CH-15.H





CH-1.H

Seating

Project: 609

Issue Date: 03 FEB 2017
Revision Date:

Mfr: Kellex Seating
33390 Liberty Parkway
North Ridgeville, OH 44039, United States
P: 440-327-4428
www.kellex.com

Rep: Susan Faulhaber
715 Briar Fork Rd.
Des Peres, MO 63131, United States
P: 314-909-7172 F: 314-909-7173
susie_faulhaber@sbcglobal.net

Contact:

Contact:

Total Qty: 0 Each Area Qty: 0 Each Bulk Qty: 0 Each Lead Time: (weeks) 8-10

- Finish Sample
- Strike-Off
- Cutting
- Shop Dwgs
- Prototype
- Seaming Diag
- CAD Drawing
- Cut Sheet
- Flame Certification

Item Name: Typical King Guestroom Lounge Chair
 Description: CUSTOM LOUNGE CHAIR
 Model #: SP20485-05
 Finish: Black
 Dimensions: 32.75"W x 31.75"D x 35"H / 18" Seat Height, 24" Arm Height
 COM yardage: 8.25 yds railroad random or 9.25 yds non-railroad random
 Notes: Semi attached, loose seat, tapered wood legs, small welt at arms, back and base, nylon glides



SPECIAL INSTRUCTIONS:

1. Nylon Glides
2. Stretchers

AREAS

Project:
Project #: 609

Issue Date: 03 FEB 2017
Revision Date:

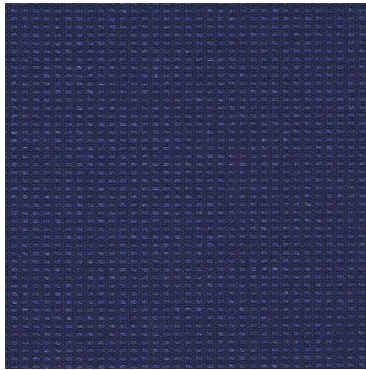

Upholstery - | Refer to F-3.H, Fabric for Lounge Chair Fronts

Mfr: Momentum Qty: 5 Lin Yds
 Pattern: Millenium
 Color: Sapphire

INSTRUCTIONS:



Upholstery - | Refer to F-6.H, Fabric for Guestroom Lounge Chair Backs

Mfr: Robert Allen Group Qty: 5 Lin Yds
 Pattern: Abstract Plaid
 Color: Cobalt

INSTRUCTIONS:



F-3.H

0

Upholstery

Project: 609







Issue Date: 03 FEB 2017
Revision Date:

Mfr: Momentum
17811 Fitch
Irvine, CA 92614, United States
P: 800.366.6839 F: 949.833.9233
www.themomgroup.com

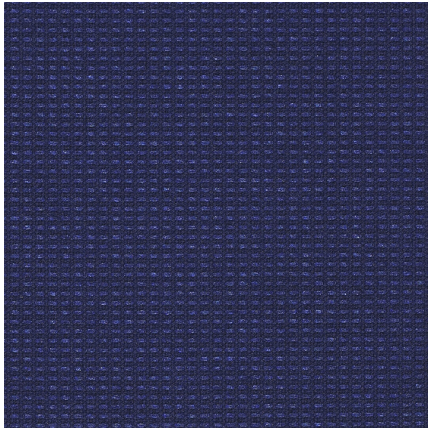
Rep: Michele Land
United States
mland@momtex.com

Contact: Michele Land
P: 800.366.6839 x845
mland@momtex.com

Contact: Default

BUDGET		REQUIRED FOR APPROVAL		
Lead Time: (weeks)	8-10	<input type="checkbox"/> Cutting	<input checked="" type="checkbox"/> 	
Bulk Qty:	8 Lin Yds	<input type="checkbox"/> Strike Off	<input checked="" type="checkbox"/> 	
Area Qty:	270 Lin Yds	<input type="checkbox"/> Cut Sheet	<input checked="" type="checkbox"/> 	
Total Qty:	278 Lin Yds	<input type="checkbox"/> Flame Certification	<input checked="" type="checkbox"/> 	
			<input checked="" type="checkbox"/> 	
			<input type="checkbox"/> 	

Item Name	Fabric for Lounge Chair Fronts
Pattern	Millenium
Product Number	09143011
Color	Sapphire
Content	85% Post consumer Recycled Polyester, 15% Polyester
Repeat	1/8"L, 1/8"W
Shown Railroaded	No
Finish	Soil & Stain Resistant
Cleaning Code	WS
Durability	200,000 D.R.
Flammability	CA Bulletin 117 2013
Dye	Piece
Backing	Acrylic
Weight	0.82 lb.
Fabric Grade	

SPECIAL INSTRUCTIONS:



F-6.H

Revision 1

Upholstery

Project: 609

Issue Date: 03 FEB 2017
Revision Date: 01 NOV 2016 (1)

Mfr: Robert Allen Group
2 Hampshire Street, Suite 300
Foxboro, MA 02035, United States
P: 800-333-3777 F: 800-332-8256

Rep: Kim Caldwell
KDR Designer Showrooms
11660 Page Service Drive
Saint Louis, MO 63146, United States
P: 314-792-0706 F: 314-993-6551
kimc@kdrshowrooms.com

Contact: Default

Contact: Default

BUDGET		REQUIRED FOR APPROVAL	
Lead Time: (weeks)	8-10	<input type="checkbox"/> Cutting	<input type="checkbox"/>
Bulk Qty:	495 Lin Yds	<input type="checkbox"/> Strike Off	<input type="checkbox"/>
Area Qty:	270 Lin Yds	<input type="checkbox"/> Cut Sheet	<input type="checkbox"/>
Total Qty:	765 Lin Yds	<input type="checkbox"/> Flame Certification	<input type="checkbox"/>
			<input type="checkbox"/>
			<input type="checkbox"/>



Item Name	Fabric for Guestroom Lounge Chair Backs
Pattern	Abstract Plaid
Model #	230087
Color	Cobalt
Content	42% Post Consumer Polyester, 37% Polyester, 21% Nylon
Repeat	Vertical: 4", Horizontal: 9"
Width	55"
Railroaded	N/A
Finish	Teflon
Cleaning Code	Pure Solvents Dry Cleaning
Abrasion	50,000 Double Rubs
Flammability	CAL 117, NFPA 260, UFAC I
Fabric Grade	06

SPECIAL INSTRUCTIONS:



CH-3.H

Seating

Project: 609

Issue Date: 03 FEB 2017
Revision Date:

Mfr: Kellex Seating
33390 Liberty Parkway
North Ridgeville, OH 44039, United States
P: 440-327-4428
www.kellex.com

Rep: Susan Faulhaber
715 Briar Fork Rd.
Des Peres, MO 63131, United States
P: 314-909-7172 F: 314-909-7173
susie_faulhaber@sbcglobal.net

Contact:

Contact:

Total Qty: 0 Each Area Qty: 0 Each Bulk Qty: 0 Each Lead Time: (weeks) 8-10

- Finish Sample
- Strike-Off
- Cutting
- Shop Dwgs
- Prototype
- Seaming Diag
- CAD Drawing
- Cut Sheet
- Flame Certification

Item Name Ottoman at Lounge Chair
 Description Oliver Cube Ottoman
 Model # 07303-00
 Finish
 Dimensions 18"W X 18"D X 18"H
 COM yardage 2 yards per ottoman
 SPECIAL INSTRUCTIONS:
 1. Nylon Glides
 2. Stretchers



AREAS



CH-3.H

Seating

Project:
Project #: 609

Issue Date: 03 FEB 2017
Revision Date:

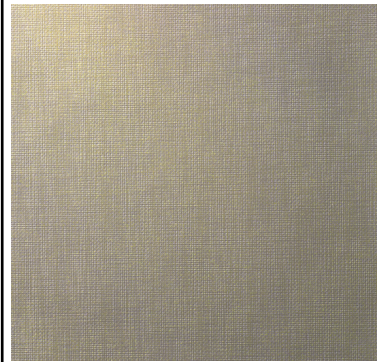

Upholstery - | Refer to F-11.H, Fabric for Suites Lounge Chair, Dining Chair Seat, Ottomans, & Luggage Benches

Mfr: D.L. Couch Qty: 2 Lin Yds

Pattern: Dante

Color: Sateen

INSTRUCTIONS:



F-11.H

Revision 1

Upholstery

Project:
Project #: 609

Issue Date: 03 FEB 2017
Revision Date: 01 NOV 2016 (1)

Mfr: D.L. Couch
499 E. County Road
300 South
New Castle, IN 47362, United States
P: 800.433.0790 F: 800.882.6824
www.dlcouch.com

Rep: Melissa Biethman
499 E. County RD 300 S.
P.O. Box 570
New Castle, IN 47362, United States
P: 314-809-7730 F: 800-882-6824

Contact: Melissa Biethman
P: 800.433.0790 C: 314.809.7730
mbiethman@dlcouch.com

Contact:

BUDGET		REQUIRED FOR APPROVAL	
Lead Time: (weeks)	8-10	<input type="checkbox"/> Cutting	<input checked="" type="checkbox"/>
Bulk Qty:	0 Lin Yds	<input type="checkbox"/> Strike Off	<input checked="" type="checkbox"/>
Area Qty:	405 Lin Yds	<input type="checkbox"/> Cut Sheet	<input checked="" type="checkbox"/>
Total Qty:	405 Lin Yds	<input type="checkbox"/> Flame Certification	<input checked="" type="checkbox"/>
			<input checked="" type="checkbox"/>
			<input type="checkbox"/>

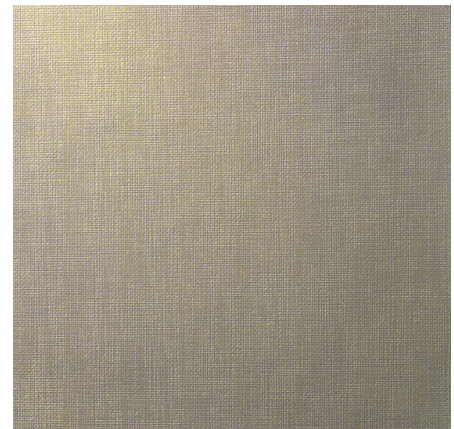

Item Name	Fabric for Suites Lounge Chair, Dining Chair Seat, Ottomans, & Luggage Benches
Pattern	Dante
Model #	UHP-DT-03
Color	Sateen
Content	45% Polyurethane (face), 55% Polyester (back)
Repeat	N/A
Width	54"
Finish	Graffiti-Free
Cleaning Code	W (water-based cleaners)
Abrasion	100,000 Double Rubs
Flammability	Passes CAL TB 117-2013 and UFAC/NFPA 260
Lightfastness	
Seam Slippage	ASTM D1683 Seam Strength: meets requirements
Breaking Strength	ASTM D2261: meets requirements
Hydrolysis Resistance	10 Weeks
Sustainability	Oeko-Tex Standard 100



F-11.H

Revision 1

Upholstery

SPECIAL INSTRUCTIONS:



CH-5.H

Seating

Project: 609

Issue Date: 03 FEB 2017
Revision Date:

Mfr: Kellex Seating
33390 Liberty Parkway
North Ridgeville, OH 44039, United States
P: 440-327-4428
www.kellex.com

Rep: Susan Faulhaber
715 Briar Fork Rd.
Des Peres, MO 63131, United States
P: 314-909-7172 F: 314-909-7173
susie_faulhaber@sbcglobal.net

Contact:

Contact:

Total Qty: 90 Each Area Qty: 0 Each Bulk Qty: 90 Each Lead Time: (weeks) 60 days

- Finish Sample
- Strike-Off
- Cutting
- Shop Dwgs
- Prototype
- Seaming Diag
- CAD Drawing
- Cut Sheet
- Flame Certification

Item Name	Lounge Chair - Double Queen Rooms
Description	Custom Antoinette Chair
Model #	SP24324-05
Finish	Black
Dimensions	28.5"W x 30.5"D x 36.5"H
Seat Height	18"
Arm Height	N/A
COM yardage	5.5 yds railroad random or 5 yds non railroad random
Notes	Standard dimensions, extend arms to front of chair, no channels on in back

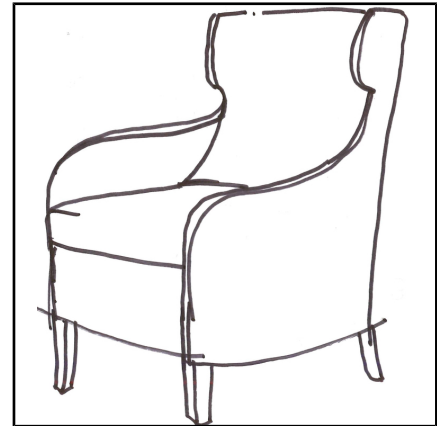

SPECIAL INSTRUCTIONS:

1. Nylon Glides
2. Stretchers

AREAS

Project:
Project #: 609

Issue Date: 03 FEB 2017
Revision Date:

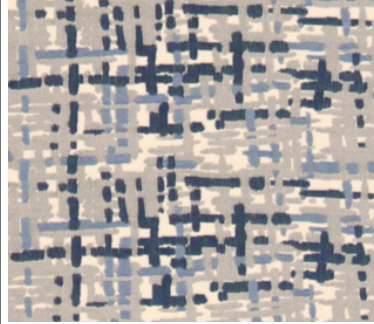

Upholstery - | Refer to F-6.H, Fabric for Guestroom Lounge Chair Backs

Mfr: Robert Allen Group Qty: 3 Lin Yds
Pattern: Abstract Plaid
Color: Cobalt

INSTRUCTIONS:

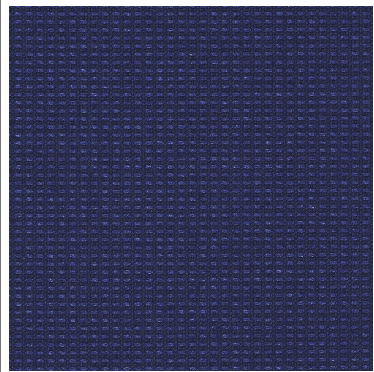

Upholstery - | Refer to F-3.H, Fabric for Lounge Chair Fronts

Mfr: Momentum Qty: 3 Lin Yds
Pattern: Millenium
Color: Sapphire

INSTRUCTIONS:



F-3.H

0

Upholstery

Project:
Project #: 609







Issue Date: 03 FEB 2017
Revision Date:

Mfr: Momentum
17811 Fitch
Irvine, CA 92614, United States
P: 800.366.6839 F: 949.833.9233
www.themomgroup.com

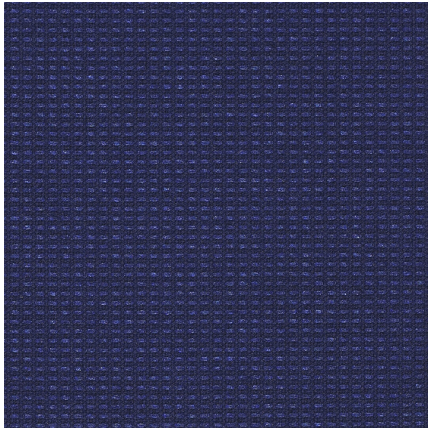
Rep: Michele Land
United States
mland@momtex.com

Contact: Michele Land
P: 800.366.6839 x845
mland@momtex.com

Contact: Default

BUDGET		REQUIRED FOR APPROVAL		
Lead Time: (weeks)	8-10	<input type="checkbox"/> Cutting	<input checked="" type="checkbox"/> 	
Bulk Qty:	8 Lin Yds	<input type="checkbox"/> Strike Off	<input checked="" type="checkbox"/> 	
Area Qty:	270 Lin Yds	<input type="checkbox"/> Cut Sheet	<input checked="" type="checkbox"/> 	
Total Qty:	278 Lin Yds	<input type="checkbox"/> Flame Certification	<input checked="" type="checkbox"/> 	
			<input checked="" type="checkbox"/> 	
			<input type="checkbox"/> 	

Item Name	Fabric for Lounge Chair Fronts
Pattern	Millenium
Product Number	09143011
Color	Sapphire
Content	85% Post consumer Recycled Polyester, 15% Polyester
Repeat	1/8"L, 1/8"W
Shown Railroaded	No
Finish	Soil & Stain Resistant
Cleaning Code	WS
Durability	200,000 D.R.
Flammability	CA Bulletin 117 2013
Dye	Piece
Backing	Acrylic
Weight	0.82 lb.
Fabric Grade	

SPECIAL INSTRUCTIONS:



F-6.H

Revision 1

Upholstery

Project: _____
Project #: 609

Issue Date: 03 FEB 2017
Revision Date: 01 NOV 2016 (1)

Mfr: Robert Allen Group
2 Hampshire Street, Suite 300
Foxboro, MA 02035, United States
P: 800-333-3777 F: 800-332-8256

Rep: Kim Caldwell
KDR Designer Showrooms
11660 Page Service Drive
Saint Louis, MO 63146, United States
P: 314-792-0706 F: 314-993-6551
kimc@kdrshowrooms.com

Contact: Default

Contact: Default

BUDGET		REQUIRED FOR APPROVAL	
Lead Time: (weeks)	8-10	<input type="checkbox"/> Cutting	<input type="checkbox"/>
Bulk Qty:	495 Lin Yds	<input type="checkbox"/> Strike Off	<input type="checkbox"/>
Area Qty:	270 Lin Yds	<input type="checkbox"/> Cut Sheet	<input type="checkbox"/>
Total Qty:	765 Lin Yds	<input type="checkbox"/> Flame Certification	<input type="checkbox"/>
			<input type="checkbox"/>
			<input type="checkbox"/>



Item Name	Fabric for Guestroom Lounge Chair Backs
Pattern	Abstract Plaid
Model #	230087
Color	Cobalt
Content	42% Post Consumer Polyester, 37% Polyester, 21% Nylon
Repeat	Vertical: 4", Horizontal: 9"
Width	55"
Railroaded	N/A
Finish	Teflon
Cleaning Code	Pure Solvents Dry Cleaning
Abrasion	50,000 Double Rubs
Flammability	CAL 117, NFPA 260, UFAC I
Fabric Grade	06

SPECIAL INSTRUCTIONS:



CH-6.H

Seating

Project: 609

Issue Date: 03 FEB 2017
Revision Date:

Mfr: Kellex Seating
33390 Liberty Parkway
North Ridgeville, OH 44039, United States
P: 440-327-4428
www.kellex.com

Rep: Susan Faulhaber
715 Briar Fork Rd.
Des Peres, MO 63131, United States
P: 314-909-7172 F: 314-909-7173
susie_faulhaber@sbcglobal.net

Contact:

Contact:

Total Qty: 150 Area Qty: 0 Bulk Qty: 150 Lead Time: (weeks)

- Finish Sample
- Strike-Off
- Cutting
- Shop Dwgs
- Prototype
- Seaming Diag
- CAD Drawing
- Cut Sheet
- Flame Certification

Item Name	Dining Chair
Description	Custom Armless Dining Chair; Added side stretchers
Model #	TBD
Wood Finish	Black
Dimensions	23.5"W x 38"H x 25.5"D
COM yardage	TBD
Seat Height	19.5"
Seat Depth	19"
Stretcher Finish	TBD

SPECIAL INSTRUCTIONS:

1. Nylon Glides
2. Stretchers



Image for design reference only. Color not accurate.

AREAS

Project:
Project #: 609

Issue Date: 03 FEB 2017
Revision Date:



Upholstery - | Refer to F-7.H, Fabric for Back of Dining Chair

Mfr:	Robert Allen Group	Qty:	1.5
Pattern:	Abstract Plaid		
Color:	Cobalt		

INSTRUCTIONS:

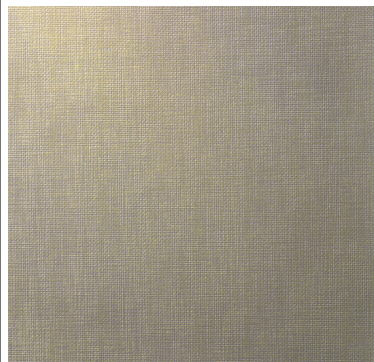

Upholstery - | Refer to F-11.H, Fabric for Suites Lounge Chair, Dining Chair Seat, Ottomans, & Luggage Benches

Mfr:	D.L. Couch	Qty:	1.5 Lin Yds
Pattern:	Dante		
Color:	Sateen		

INSTRUCTIONS:



F-7.H

0

Upholstery

Project: 609

Issue Date: 03 FEB 2017
Revision Date:

Mfr: Robert Allen Group
2 Hampshire Street, Suite 300
Foxboro, MA 02035, United States
P: 800-333-3777 F: 800-332-8256

Rep: Kim Caldwell
KDR Designer Showrooms
11660 Page Service Drive
Saint Louis, MO 63146, United States
P: 314-792-0706 F: 314-993-6551
kimc@kdrshowrooms.com

Contact: Default

Contact: Default

BUDGET		REQUIRED FOR APPROVAL	
Lead Time: (weeks)		<input type="checkbox"/> Cutting	<input checked="" type="checkbox"/>
Bulk Qty:	2	<input type="checkbox"/> Strike Off	<input checked="" type="checkbox"/>
Area Qty:	225	<input type="checkbox"/> Cut Sheet	<input checked="" type="checkbox"/>
Total Qty:	227	<input type="checkbox"/> Flame Certification	<input checked="" type="checkbox"/>
			<input checked="" type="checkbox"/>
			<input type="checkbox"/>



Item Name	Fabric for Back of Dining Chair
Pattern	Abstract Plaid
SKU	230087
Color	Cobalt
Content	42% Post Consumer Polyester, 37% Polyester, 21% Nylon
Repeat	Horizontal 9, Vertical 4
Width	55"
Flammability	CA 117 2013
Repeat Direction	Up the Roll
Fabric Grade	06

SPECIAL INSTRUCTIONS:



F-11.H

Revision 1

Upholstery

Project:
Project #: 609

Issue Date: 03 FEB 2017
Revision Date: 01 NOV 2016 (1)

Mfr: D.L. Couch
499 E. County Road
300 South
New Castle, IN 47362, United States
P: 800.433.0790 F: 800.882.6824
www.dlcouch.com

Rep: Melissa Biethman
499 E. County RD 300 S.
P.O. Box 570
New Castle, IN 47362, United States
P: 314-809-7730 F: 800-882-6824

Contact: Melissa Biethman
P: 800.433.0790 C: 314.809.7730
mbiethman@dlcouch.com

Contact:

BUDGET		REQUIRED FOR APPROVAL	
Lead Time: (weeks)	8-10	<input type="checkbox"/> Cutting	<input checked="" type="checkbox"/>
Bulk Qty:	0 Lin Yds	<input type="checkbox"/> Strike Off	<input checked="" type="checkbox"/>
Area Qty:	405 Lin Yds	<input type="checkbox"/> Cut Sheet	<input checked="" type="checkbox"/>
Total Qty:	405 Lin Yds	<input type="checkbox"/> Flame Certification	<input checked="" type="checkbox"/>
			<input checked="" type="checkbox"/>
			<input type="checkbox"/>

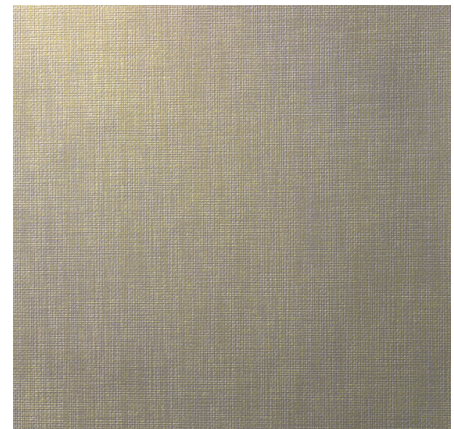

Item Name	Fabric for Suites Lounge Chair, Dining Chair Seat, Ottomans, & Luggage Benches
Pattern	Dante
Model #	UHP-DT-03
Color	Sateen
Content	45% Polyurethane (face), 55% Polyester (back)
Repeat	N/A
Width	54"
Finish	Graffiti-Free
Cleaning Code	W (water-based cleaners)
Abrasion	100,000 Double Rubs
Flammability	Passes CAL TB 117-2013 and UFAC/NFPA 260
Lightfastness	
Seam Slippage	ASTM D1683 Seam Strength: meets requirements
Breaking Strength	ASTM D2261: meets requirements
Hydrolysis Resistance	10 Weeks
Sustainability	Oeko-Tex Standard 100



F-11.H

Revision 1

Upholstery

SPECIAL INSTRUCTIONS:



CH-7.H

Seating

Project: 609

Issue Date: 03 FEB 2017
Revision Date:

Mfr: Kellex Seating
33390 Liberty Parkway
North Ridgeville, OH 44039, United States
P: 440-327-4428
www.kellex.com

Rep: Susan Faulhaber
715 Briar Fork Rd.
Des Peres, MO 63131, United States
P: 314-909-7172 F: 314-909-7173
susie_faulhaber@sbcglobal.net

Contact:

Contact:

Total Qty: 0 Each Area Qty: 0 Each Bulk Qty: 0 Each Lead Time: (weeks) 8-10

- Finish Sample
- Strike-Off
- Cutting
- Shop Dwgs
- Prototype
- Seaming Diag
- CAD Drawing
- Cut Sheet
- Flame Certification

Item Name: Desk Chair
 Description: Channel Back Ergo Guest Chair with Chrome Base and Black Casters
 Model #: ER13500-MNA TENNIE ERGO CHAIR W/ METAL BASE
 Finish: Chrome
 Dimensions: 23.75"W x 24.25"D x 37"-39.5"H
 COM yardage: 1.25 yds railroaded random or 1.5 yards non-railroaded
 Arm Height: N/A
 Seat Height: 18.75"-21.5"
 SPECIAL INSTRUCTIONS:
 1. Nylon Glides
 2. Stretchers



AREAS



Project: AK-CHIN HOTEL
Project #: 609

Issue Date: 03 FEB 2017
Revision Date:

Upholstery - | Refer to F-9.H, Fabric For Desk Chair

Mfr: Momentum Qty: 1.25 Lin Yds
Pattern: Silica
Color: Sketch

INSTRUCTIONS:



F-9.H

0

Upholstery

Project: 609

Issue Date: 03 FEB 2017
Revision Date:

Mfr: Momentum
17811 Fitch
Irvine, CA 92614, United States
P: 800.366.6839 F: 949.833.9233
www.themomgroup.com

Rep: Michele Land
United States
mland@momtex.com

Contact: Michele Land
P: 800.366.6839 x845
mland@momtex.com

Contact: Default

BUDGET		REQUIRED FOR APPROVAL	
Lead Time: (weeks)	8-10	<input type="checkbox"/> Cutting	<input checked="" type="checkbox"/>
Bulk Qty:	4 Lin Yds	<input type="checkbox"/> Strike Off	<input checked="" type="checkbox"/>
Area Qty:	0 Lin Yds	<input type="checkbox"/> Cut Sheet	<input checked="" type="checkbox"/>
Total Qty:	4 Lin Yds	<input type="checkbox"/> Flame Certification	<input checked="" type="checkbox"/>
			<input checked="" type="checkbox"/>
			<input type="checkbox"/>

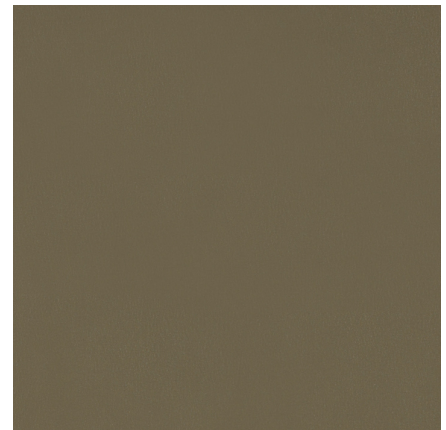

Item Name	Fabric For Desk Chair
Pattern	Silica
Model #	09126621
Color	Sketch
Content	100% Silicone
Backing	Polyester
Repeat	NA
Width	54"
Railroaded	No
Weight	1.60 lb
Finish	-
Maintenance	WS- Water-Based Cleaning Agents or Foam; Bleach Cleanable
Abrasion	365,000 D.R.
Flammability	CA Bulletin 117 2013; UFAC Class 1; NFPA 260 Class 1

SPECIAL INSTRUCTIONS:



CH-8.H

Seating

Project: 609

Issue Date: 03 FEB 2017
Revision Date:

Mfr: Kellex Seating
33390 Liberty Parkway
North Ridgeville, OH 44039, United States
P: 440-327-4428
www.kellex.com

Rep: Susan Faulhaber
715 Briar Fork Rd.
Des Peres, MO 63131, United States
P: 314-909-7172 F: 314-909-7173
susie_faulhaber@sbcglobal.net

Contact:

Contact:

Total Qty: 60 Each Area Qty: 0 Each Bulk Qty: 60 Each Lead Time: (weeks) 60 days

- Finish Sample
- Strike-Off
- Cutting
- Shop Dwgs
- Prototype
- Seaming Diag
- CAD Drawing
- Cut Sheet
- Flame Certification

Item Name: Luggage Bench - with Back

Description: Custom luggage bench with metal back rail. Tightly upholstered top, metal base with straight metal legs, metal framed back with open space.

Model #: SP24168-15

Finish: Metal

Dimensions: 36"W x 18"D x 22"H

COM yardage: 3 yds per luggage bench

SPECIAL INSTRUCTIONS:

1. Nylon Glides
2. Stretchers



Image for reference only, Color not accurate.

AREAS



CH-8.H

Seating

Project:
Project #: 609

Issue Date: 03 FEB 2017
Revision Date:

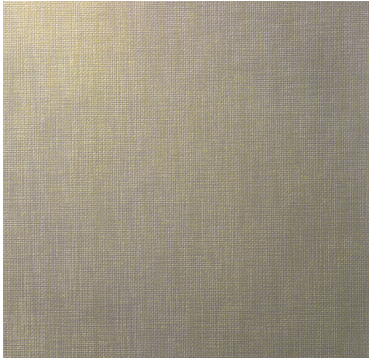
	Upholstery - Refer to F-11.H, Fabric for Suites Lounge Chair, Dining Chair Seat, Ottomans, & Luggage Benches		
	Mfr:	D.L. Couch	Qty: 3 Lin Yds
	Pattern:	Dante	
	Color:	Sateen	
<hr/>			
INSTRUCTIONS:			



F-11.H

Revision 1

Upholstery

Project:
Project #: 609

Issue Date: 03 FEB 2017
Revision Date: 01 NOV 2016 (1)

Mfr: D.L. Couch
499 E. County Road
300 South
New Castle, IN 47362, United States
P: 800.433.0790 F: 800.882.6824
www.dlcouch.com

Rep: Melissa Biethman
499 E. County RD 300 S.
P.O. Box 570
New Castle, IN 47362, United States
P: 314-809-7730 F: 800-882-6824

Contact: Melissa Biethman
P: 800.433.0790 C: 314.809.7730
mbiethman@dlcouch.com

Contact:

BUDGET		REQUIRED FOR APPROVAL	
Lead Time: (weeks)	8-10	<input type="checkbox"/> Cutting	<input checked="" type="checkbox"/>
Bulk Qty:	0 Lin Yds	<input type="checkbox"/> Strike Off	<input checked="" type="checkbox"/>
Area Qty:	405 Lin Yds	<input type="checkbox"/> Cut Sheet	<input checked="" type="checkbox"/>
Total Qty:	405 Lin Yds	<input type="checkbox"/> Flame Certification	<input checked="" type="checkbox"/>
			<input checked="" type="checkbox"/>
			<input type="checkbox"/>

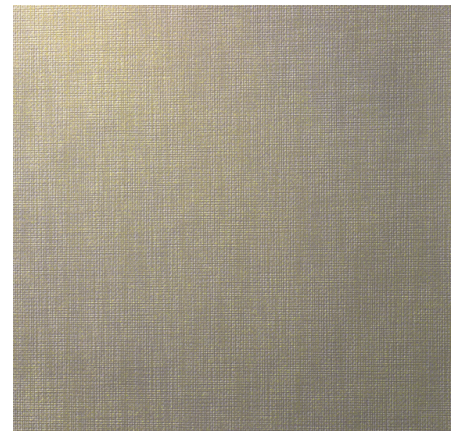

Item Name	Fabric for Suites Lounge Chair, Dining Chair Seat, Ottomans, & Luggage Benches
Pattern	Dante
Model #	UHP-DT-03
Color	Sateen
Content	45% Polyurethane (face), 55% Polyester (back)
Repeat	N/A
Width	54"
Finish	Graffiti-Free
Cleaning Code	W (water-based cleaners)
Abrasion	100,000 Double Rubs
Flammability	Passes CAL TB 117-2013 and UFAC/NFPA 260
Lightfastness	
Seam Slippage	ASTM D1683 Seam Strength: meets requirements
Breaking Strength	ASTM D2261: meets requirements
Hydrolysis Resistance	10 Weeks
Sustainability	Oeko-Tex Standard 100



F-11.H

Revision 1

Upholstery

SPECIAL INSTRUCTIONS:



CH-9.H

Seating

Project: 609

Issue Date: 03 FEB 2017
Revision Date:

Mfr: **Kellex Seating**
33390 Liberty Parkway
North Ridgeville, OH 44039, United States
P: 440-327-4428
www.kellex.com

Rep: Susan Faulhaber
715 Briar Fork Rd.
Des Peres, MO 63131, United States
P: 314-909-7172 F: 314-909-7173
susie_faulhaber@sbcglobal.net

Contact:

Contact:

Total Qty: 0 Each Area Qty: 0 Each Bulk Qty: 0 Each Lead Time: (weeks) 8-10

- Finish Sample
- Strike-Off
- Cutting
- Shop Dwgs
- Prototype
- Seaming Diag
- CAD Drawing
- Cut Sheet
- Flame Certification

Item Name: Luggage Bench - without back

Description: Custom Luggage bench with metal base. Tightly upholstered top, metal base with straight metal legs.

Model #: SP24167-15

Finish: Metal

Dimensions: 36"W x 18"D x 22"H

COM yardage: 3 yds per bench

SPECIAL INSTRUCTIONS:

1. Nylon Glides
2. Stretchers



Image for reference only, color not accurate.

AREAS



CH-9.H

Seating

Project:
Project #: 609

Issue Date: 03 FEB 2017
Revision Date:

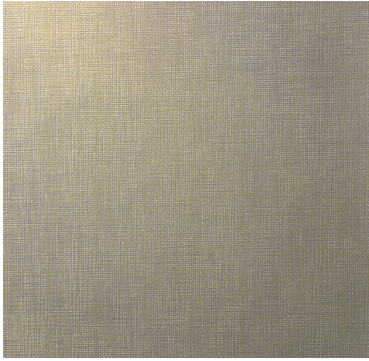
	Upholstery - Refer to F-11.H, Fabric for Suites Lounge Chair, Dining Chair Seat, Ottomans, & Luggage Benches		
	Mfr:	D.L. Couch	Qty: 3 Lin Yds
	Pattern:	Dante	
	Color:	Sateen	
<hr/>			
INSTRUCTIONS:			



F-11.H

Revision 1

Upholstery

Project:
Project #: 609

Issue Date: 03 FEB 2017
Revision Date: 01 NOV 2016 (1)

Mfr: D.L. Couch
499 E. County Road
300 South
New Castle, IN 47362, United States
P: 800.433.0790 F: 800.882.6824
www.dlcouch.com

Rep: Melissa Biethman
499 E. County RD 300 S.
P.O. Box 570
New Castle, IN 47362, United States
P: 314-809-7730 F: 800-882-6824

Contact: Melissa Biethman
P: 800.433.0790 C: 314.809.7730
mbiethman@dlcouch.com

Contact:

BUDGET		REQUIRED FOR APPROVAL	
Lead Time: (weeks)	8-10	<input type="checkbox"/> Cutting	<input checked="" type="checkbox"/>
Bulk Qty:	0 Lin Yds	<input type="checkbox"/> Strike Off	<input checked="" type="checkbox"/>
Area Qty:	405 Lin Yds	<input type="checkbox"/> Cut Sheet	<input checked="" type="checkbox"/>
Total Qty:	405 Lin Yds	<input type="checkbox"/> Flame Certification	<input checked="" type="checkbox"/>
			<input checked="" type="checkbox"/>
			<input type="checkbox"/>

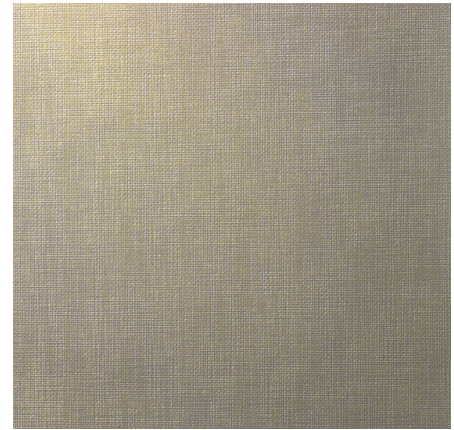

Item Name	Fabric for Suites Lounge Chair, Dining Chair Seat, Ottomans, & Luggage Benches
Pattern	Dante
Model #	UHP-DT-03
Color	Sateen
Content	45% Polyurethane (face), 55% Polyester (back)
Repeat	N/A
Width	54"
Finish	Graffiti-Free
Cleaning Code	W (water-based cleaners)
Abrasion	100,000 Double Rubs
Flammability	Passes CAL TB 117-2013 and UFAC/NFPA 260
Lightfastness	
Seam Slippage	ASTM D1683 Seam Strength: meets requirements
Breaking Strength	ASTM D2261: meets requirements
Hydrolysis Resistance	10 Weeks
Sustainability	Oeko-Tex Standard 100



F-11.H

Revision 1

Upholstery

SPECIAL INSTRUCTIONS:



CH-10.H

Seating

Project:

Issue Date:

03 FEB 2017

Project #: 609

Revision Date:

Mfr: Bernhardt Textiles
 1839 Morganton Blvd.
 P.O. Box 740
 Lenoir, NC 28645, United States
 P: 828-758-9811
 www.bernhardttextiles.com

Rep: Karma Lamping
 United States
 kll1491@msn.com

Contact:

Contact:

Total Qty: 0 Each

Area Qty: 0 Each

Bulk Qty: 0 Each

Lead Time: (weeks) 8-10

Finish Sample

Strike-Off

Cutting

Shop Dwgs

Prototype

Seaming Diag

CAD Drawing

Cut Sheet

Flame Certification

Item Name Suites Lounge Chair
 Description Jaxon Chair
 Model # N3522
 Finish Gun Metal only
 Dimensions 29-1/2"W x 32-1/2"D x 31-1/2"H. 17"SH x 24"AH x 24-1/2"SD x 22-1/2"BA
 COM yardage 6 yds per chair based on 54" non-repeat fabric
 Construction Sinuous Spring
 Cushion Luxe Down



SPECIAL INSTRUCTIONS:

1. Nylon Glides
2. Stretchers

AREAS



CH-10.H

Seating

Project:
Project #: 609

Issue Date: 03 FEB 2017
Revision Date:

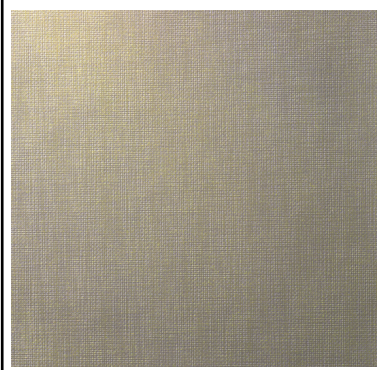

Upholstery - | Refer to F-11.H, Fabric for Suites Lounge Chair, Dining Chair Seat, Ottomans, & Luggage Benches

Mfr:	D.L. Couch	Qty:	6 Lin Yds
Pattern:	Dante		
Color:	Sateen		

INSTRUCTIONS:



F-11.H

Revision 1

Upholstery

Project:
Project #: 609

Issue Date: 03 FEB 2017
Revision Date: 01 NOV 2016 (1)

Mfr: D.L. Couch
499 E. County Road
300 South
New Castle, IN 47362, United States
P: 800.433.0790 F: 800.882.6824
www.dlcouch.com

Rep: Melissa Biethman
499 E. County RD 300 S.
P.O. Box 570
New Castle, IN 47362, United States
P: 314-809-7730 F: 800-882-6824

Contact: Melissa Biethman
P: 800.433.0790 C: 314.809.7730
mbiethman@dlcouch.com

Contact:

BUDGET		REQUIRED FOR APPROVAL	
Lead Time: (weeks)	8-10	<input type="checkbox"/> Cutting	<input checked="" type="checkbox"/>
Bulk Qty:	0 Lin Yds	<input type="checkbox"/> Strike Off	<input checked="" type="checkbox"/>
Area Qty:	405 Lin Yds	<input type="checkbox"/> Cut Sheet	<input checked="" type="checkbox"/>
Total Qty:	405 Lin Yds	<input type="checkbox"/> Flame Certification	<input checked="" type="checkbox"/>
			<input checked="" type="checkbox"/>
			<input type="checkbox"/>

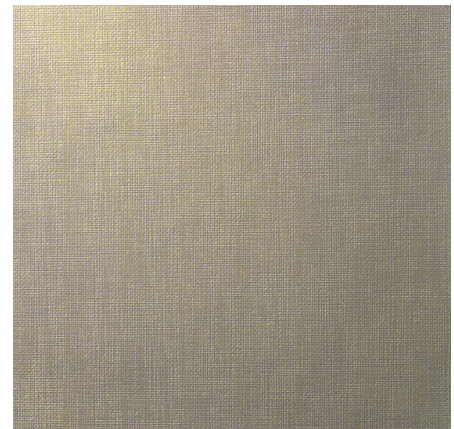

Item Name	Fabric for Suites Lounge Chair, Dining Chair Seat, Ottomans, & Luggage Benches
Pattern	Dante
Model #	UHP-DT-03
Color	Sateen
Content	45% Polyurethane (face), 55% Polyester (back)
Repeat	N/A
Width	54"
Finish	Graffiti-Free
Cleaning Code	W (water-based cleaners)
Abrasion	100,000 Double Rubs
Flammability	Passes CAL TB 117-2013 and UFAC/NFPA 260
Lightfastness	
Seam Slippage	ASTM D1683 Seam Strength: meets requirements
Breaking Strength	ASTM D2261: meets requirements
Hydrolysis Resistance	10 Weeks
Sustainability	Oeko-Tex Standard 100



F-11.H

Revision 1

Upholstery

SPECIAL INSTRUCTIONS:



CH-11.H

Seating

Project: 609

Issue Date: 03 FEB 2017
Revision Date:

Mfr: Kellex Seating
33390 Liberty Parkway
North Ridgeville, OH 44039, United States
P: 440-327-4428
www.kellex.com

Rep: Susan Faulhaber
715 Briar Fork Rd.
Des Peres, MO 63131, United States
P: 314-909-7172 F: 314-909-7173
susie_faulhaber@sbcglobal.net

Contact:

Contact:

Total Qty: 33 Each Area Qty: 0 Each Bulk Qty: 33 Each Lead Time: (weeks) 60 days

- Finish Sample
- Strike-Off
- Cutting
- Shop Dwgs
- Prototype
- Seaming Diag
- CAD Drawing
- Cut Sheet
- Flame Certification

Item Name: Queen Sofa Sleeper

Description: Custom Queen Sleeper. 2 total 14" Welled Accent Pillows (Fiber Filled), 2 Loose Reversible Box Style Seat Cushions-No Welt (1.8hr), 2 Semi-Attached Box Style Back Cushions-No Welt (Foam with Fiber Wrap).

Model #: SP24165-50

Dimensions: 81"W x 36"D x 34"H

COM yardage: Sofa Body: 16.5 yds railroad random or 19 yds non-railroad random. Pillows: 2 yds.

Arm Style: Tightly upholstered

Base: Wood sleigh base to extend up front and back of arms (Max 3.5" Leg height allowed for sleepers)

Sofa Mattress: L&P Classic square 3568 with Kellex Standard 5" Platinum Mattress



SPECIAL INSTRUCTIONS:

1. Nylon Glides
2. Stretchers
3. Backs to extend 4" above 30"H back rail for 34" overall height

AREAS

Project:
Project #: 609

Issue Date: 03 FEB 2017
Revision Date:



Upholstery - | Refer to F-12.H, Fabric For Sofa Sleeper

Mfr:	Designtex	Qty:	16.5 Lin Yds
Pattern:	Hashtag		
Color:	Chalkboard		

INSTRUCTIONS:



F-12.H

0

Upholstery

Project:
Project #: 609

Issue Date: 03 FEB 2017
Revision Date:

Mfr: Designtex
P: 800.221.1540
www.designtex.com

Rep: Glenda Jehle
4731 McPherson
Saint Louis, MO 63108, United States
P: 314-863-2228 F: 303-722-7703

Contact: Glenda Jehle
P: 314.863.2228 C: 314.922.6590
gjehe@dtex.com

Contact: Default

BUDGET

REQUIRED FOR APPROVAL

Lead Time: (weeks)	8-10
Bulk Qty:	0 Lin Yds
Area Qty:	544 Lin Yds
Total Qty:	544 Lin Yds

- | | | | |
|--------------------------|---------------------|-------------------------------------|--|
| <input type="checkbox"/> | Cutting | <input checked="" type="checkbox"/> | |
| <input type="checkbox"/> | Strike Off | <input checked="" type="checkbox"/> | |
| <input type="checkbox"/> | Cut Sheet | <input checked="" type="checkbox"/> | |
| <input type="checkbox"/> | Flame Certification | <input checked="" type="checkbox"/> | |
| | | <input checked="" type="checkbox"/> | |
| | | <input type="checkbox"/> | |



Item Name	Fabric For Sofa Sleeper
Pattern	Hashtag
Model #	3662-803
Color	Chalkboard
Content	47% Acrylic, 53% Polyester
Backing	Acrylic
Width	54"
Shown Railroaded	No
Weight	18 oz/ly
Finish	Stain Repellent
Cleaning Code	Water-based/Solvent (WS)
Abrasion	80,000 Double Rubs
Flammability	CA TB 117-2013 , NFPA 260
Lightfastness	40 hours

SPECIAL INSTRUCTIONS:



CH-14.H

Seating

Project: 609

Issue Date: 03 FEB 2017
Revision Date:

Mfr: Kellex Seating
33390 Liberty Parkway
North Ridgeville, OH 44039, United States
P: 440-327-4428
www.kellex.com

Rep: Susan Faulhaber
715 Briar Fork Rd.
Des Peres, MO 63131, United States
P: 314-909-7172 F: 314-909-7173
susie_faulhaber@sbcglobal.net

Contact:

Contact:

Total Qty: 2 Each Area Qty: 0 Each Bulk Qty: 2 Each Lead Time: (weeks) 8-10

- Finish Sample
- Strike-Off
- Cutting
- Shop Dwgs
- Prototype
- Seaming Diag
- CAD Drawing
- Cut Sheet
- Flame Certification

Item Name: Pillow For Sofa Sleepers
 Description: 14" Welled Accent Pillows
 Model #: 9000-14
 Dimensions: 14" x 14"
 COM yardage: 1 yd per pillow

SPECIAL INSTRUCTIONS:

1. Nylon Glides
2. Stretchers

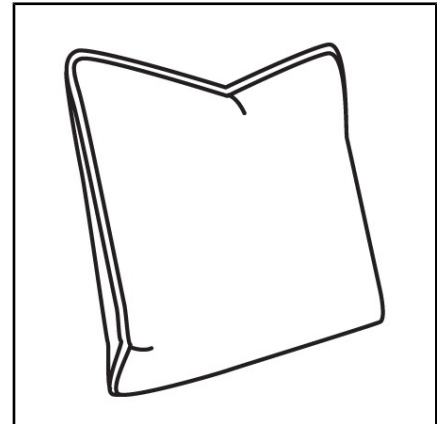

AREAS

Project:
Project #: 609

Issue Date: 03 FEB 2017
Revision Date:



Upholstery - | Refer to F-13.H, Fabric For Pillow Sofas Sleepers

Mfr:	Paul Brayton Designs	Qty:	1 Lin Yds
Pattern:	Prizm		
Color:	Pipeline		

INSTRUCTIONS:



F-13.H

0

Upholstery

Project: 609







Issue Date: 03 FEB 2017
Revision Date:

Mfr: Paul Brayton Designs
403 Interstate Drive
Archdale, NC 27263, United States
P: 336.882-5200
www.paulbraytondesigns.com

Rep: Liz Buhr and Company
United States
P: 314-412-2120 F: 847-657-7641
lbuhr@sbcglobal.net

Contact: Default

Contact: Default

BUDGET		REQUIRED FOR APPROVAL		
Lead Time: (weeks)	8-10	<input checked="" type="checkbox"/> Cutting	<input checked="" type="checkbox"/> 	
Bulk Qty:	0 Lin Yds	<input type="checkbox"/> Strike Off	<input checked="" type="checkbox"/> 	
Area Qty:	2 Lin Yds	<input checked="" type="checkbox"/> Cut Sheet	<input checked="" type="checkbox"/> 	
Total Qty:	2 Lin Yds	<input checked="" type="checkbox"/> Flame Certification	<input checked="" type="checkbox"/> 	
			<input checked="" type="checkbox"/> 	
			<input type="checkbox"/> 	

Item Name	Fabric For Pillow Sofas Sleepers
Pattern	Prizm
Model #	PR-45
Color	Pipeline
Content	65% Rayon, 35% Recycled Solution Dyed Nylon
Backing	Light Acrylic
Repeat	14.2"H X 12"V
Width	54"
Railroad	No
Finish	Incase
Cleaning Code	S
Abrasion	50,000+ DR
Flammability	California Technical Bulletin 117: 2013

SPECIAL INSTRUCTIONS:



CH-15.H

Seating

Project: 609

Issue Date: 03 FEB 2017
Revision Date:

Mfr: Kellex Seating
33390 Liberty Parkway
North Ridgeville, OH 44039, United States
P: 440-327-4428
www.kellex.com

Rep: Susan Faulhaber
715 Briar Fork Rd.
Des Peres, MO 63131, United States
P: 314-909-7172 F: 314-909-7173
susie_faulhaber@sbcglobal.net

Contact:

Contact:

Total Qty: 0 Area Qty: 0 Bulk Qty: 0 Lead Time: (weeks) 8-10

- Finish Sample
- Strike-Off
- Cutting
- Shop Dwgs
- Prototype
- Seaming Diag
- CAD Drawing
- Cut Sheet
- Flame Certification

Item Name Ottoman at Sofa Sleepers
 Description Oliver Cube Ottoman
 Model # 07303-00
 Dimensions 18"W x 18"D x 18"H
 COM yardage 2 yds per ottoman
 Seat Height 18"
 Arm Height N/A

SPECIAL INSTRUCTIONS:

1. Nylon Glides
2. Stretchers

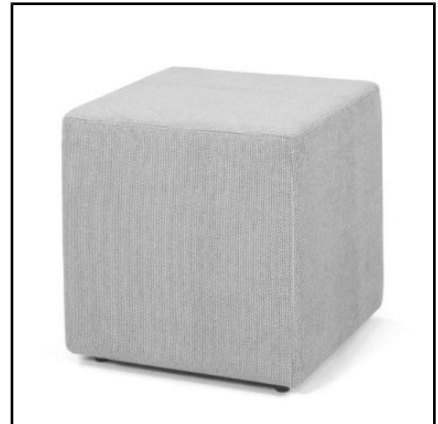

AREAS



CH-15.H

Seating

Project:
Project #: 609

Issue Date: 03 FEB 2017
Revision Date:

Upholstery - | Refer to F-15.H, Fabric For Sofa Sleeper Ottomans

Mfr:	Designtex	Qty:	2 Lin Yds
Pattern:	Rove		
Color:	Midnight		

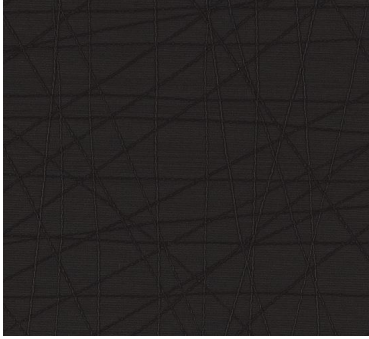

INSTRUCTIONS:



F-15.H

0

Upholstery

Project:
Project #: 609

Issue Date: 03 FEB 2017
Revision Date:

Mfr: Designtex
P: 800.221.1540
www.designtex.com

Rep: Glenda Jehle
4731 McPherson
Saint Louis, MO 63108, United States
P: 314-863-2228 F: 303-722-7703

Contact: Glenda Jehle
P: 314.863.2228 C: 314.922.6590
gjehle@dtex.com

Contact: Default

BUDGET

REQUIRED FOR APPROVAL

Lead Time: (weeks)	8-10
Bulk Qty:	0 Lin Yds
Area Qty:	0 Lin Yds
Total Qty:	0 Lin Yds

- | | | | |
|--------------------------|---------------------|-------------------------------------|--|
| <input type="checkbox"/> | Cutting | <input checked="" type="checkbox"/> | |
| <input type="checkbox"/> | Strike Off | <input checked="" type="checkbox"/> | |
| <input type="checkbox"/> | Cut Sheet | <input checked="" type="checkbox"/> | |
| <input type="checkbox"/> | Flame Certification | <input checked="" type="checkbox"/> | |
| | | <input checked="" type="checkbox"/> | |
| | | <input type="checkbox"/> | |

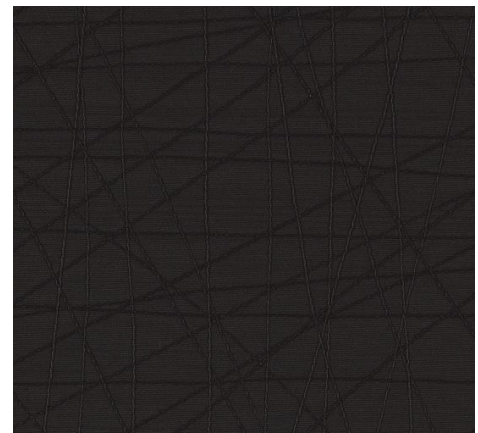

Item Name	Fabric For Sofa Sleeper Ottomans
Pattern	Rove
Model #	3630-804
Color	Midnight
Content	100% Vinyl
Backing	Cotton, Woven
Repeat	Vertical: 14.3" x Horizontal: 18"
Width	59"
Shown Railroaded	No
Weight	41.3 oz/ly
Cleaning Code	W, Bleach Cleanable (10:1)
Abrasion	100,000 Wyzenbeek
Flammability	CA TB 117-2013 , NFPA 260
Lightfastness	40 hours

SPECIAL INSTRUCTIONS:

Casegoods



Item Report By Item Type

Project:

Project #: 609

Issue Date: 03 FEB 2017

ItemType: Casegoods

Control #	Item Name	Total Qty	Unit	Item Cost	Total Cost	Revision Date
CG-1.H	King Headboard	0	Each			
CG-2.H	Queen Headboard	0	Each			
CG-3.H	24" Nightstand/Panel Combo	0	Each			
CG-4.H	30" Nightstand/Panel Combo	0	Each			
CG-5.H	36" Nightstand/Panel Combo (ADA)	0	Each			
CG-6.H	King Bed Base	0	Each			
CG-7.H	Queen Bed Base	0	Each			
CG-8.H	Double Queen Power Shelf	0	Each			
CG-9.H	Dresser - 72"W	0	Each			29 NOV 2016 (1)
CG-10.H	Dresser - 54"W Suites	0	Each			29 NOV 2016 (1)
CG-11.H	Desk LH - 48"W	0	Each			29 NOV 2016 (1)
CG-12.H	Desk RH - 48"W	0	Each			29 NOV 2016 (1)
CG-14.H	TV Wall Panel	0	Each			
CG-15.H	Dining Table - 36" Diameter	0				
CG-17.H	Double Queen Occasional Table	0	Each			
CG-18.H	Activity Table 30" Dia.	0				
CG-21.H	Typical Guestroom Vanity	0	Each			
CG-22.H	Hotel Tower Elevator Lobby Console Table	10	Each			
CG-23.H	Suites Console Table	0	Each			
CG-25.H	Accessible Guestroom Vanity	0	Each			20 DEC 2016 (1)
CG-26.H	2 Room Suite Accessible Guestroom Vanity	0	Each			20 DEC 2016 (1)
CG-27.H	Guestroom Vanity - 5'	0	Each			
CG-28.H	2 Room Suites Vanity - Angled Top	0	Each			
CG-29.H	2 Room Suites Powder Room Vanity	0	Each			
CG-30.H	Refrigerator Drybar with LH Panel	0	Each			
CG-31.H	Refrigerator Drybar with RH Panel	0	Each			
CG-32.H	Refrigerator Drybar with LH Waterfall - No Panel	0	Each			
CG-33.H	Refrigerator Drybar with RH Waterfall - No Panel	0	Each			
CG-34.H	Refrigerator Drybar - No Waterfall or Panel	0	Each			
CG-35.H	2 Room Suite Drybar	0	Each			
CG-36.H	ADA 2 Room Suite Drybar	0	Each			
CG-37.H	Extended King Dresser/Drybar Combo	0	Each			20 DEC 2016 (1)
CG-38.H	2 Room Suite TV Console	0	Each			20 DEC 2016 (1)
CG-39.H	Desk - 48"W Extended King	0	Each			29 NOV 2016 (1)

CG-1.H



CG-2.H



CG-3.H

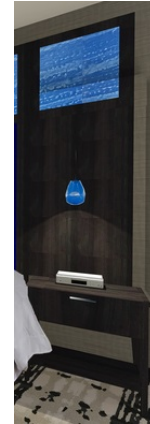

CG-4.H

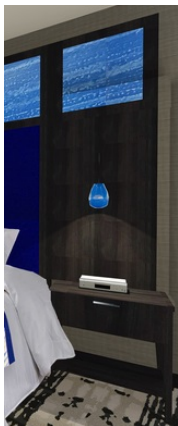

CG-5.H

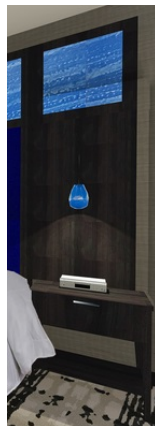

CG-6.H

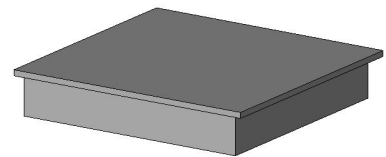

CG-7.H

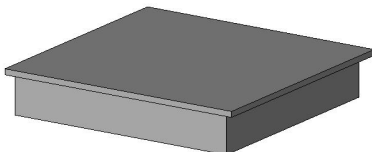

CG-8.H



CG-9.H



CG-10.H



CG-11.H



CG-12.H



CG-14.H



CG-15.H



CG-17.H



CG-18.H



CG-21.H



CG-22.H



CG-23.H



CG-25.H

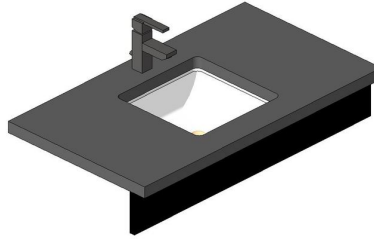

CG-26.H

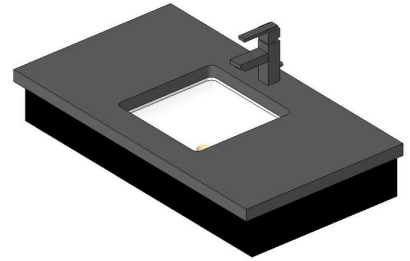

CG-27.H

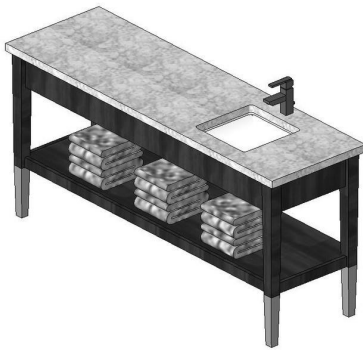

CG-28.H

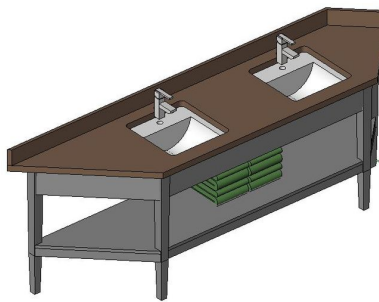

CG-29.H

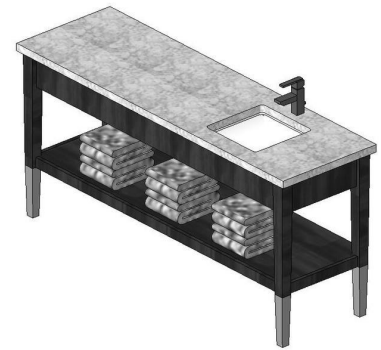

CG-30.H



CG-31.H

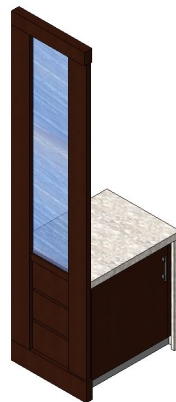

CG-32.H

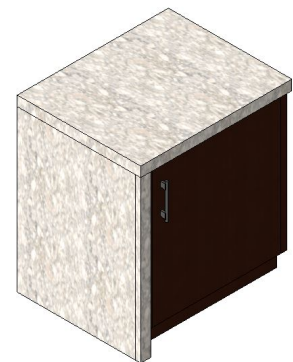



Image Report By Item Type

Project:

Project #: 609

Issue Date: 03 FEB 2017

Item Type: Casegoods

CG-33.H

CG-34.H

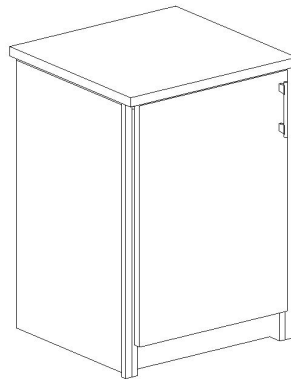

CG-35.H

CG-36.H

CG-37.H



CG-38.H

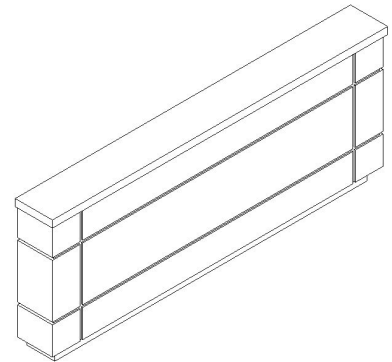

CG-39.H





CG-1.H

Casegoods

Project: 609

Issue Date: 03 FEB 2017
Revision Date:

Mfr: HF Collection
465 Forbes Blvd
South San Francisco, CA 94080, United States
P: 650-952-2546 F: 650-952-2681
www.hf-collection.com

Rep: Sarah Turner
United States
P: 650-952-2546 F: 650-952-2681
sarah@hf-collection.com

Contact:

Contact:

Total Qty: 0 Each Area Qty: 0 Each Bulk Qty: 0 Each Lead Time: (weeks) 10-12

- Finish Sample
- Strike-Off
- Cutting
- Shop Dwgs
- Prototype
- Seaming Diag
- CAD Drawing
- Cut Sheet
- Flame Certification

Item Name: King Headboard
 Description: Custom Tufted King Headboard with Backlit Acrylic Panel
 Acrylic Finish: Envel Rice Paper - Weekend Sky
 Wood Finish: Stain to match Arborite - W448 LQ
 Dimensions: 7'-0" W x 4" D x 7'-2"H
 Light Box Description: Light Box Panel to be hinged at top along back edge. Light to be mounted on the under side of the hinged top. Nightstand back panels to be coordinated as they will all share a single light strip.
 COM: 5 yds
 SPECIAL INSTRUCTIONS:
 1. Upholstery to be Attached: F-1.H Custom Silica/ ML5442-A2
 2. Please Refer to TBE Standard Construction Standards

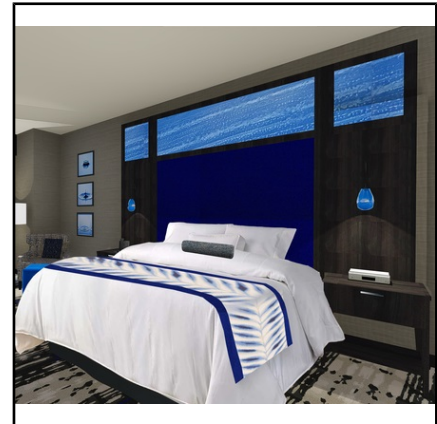

Front Elevation

AREAS

Project: 609
Project #:

Issue Date: 03 FEB 2017
Revision Date:

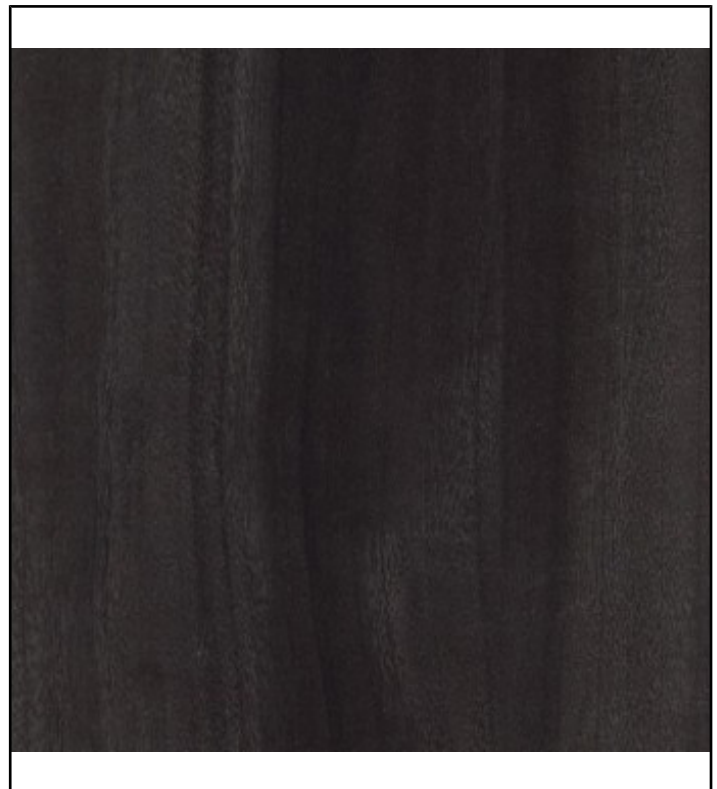
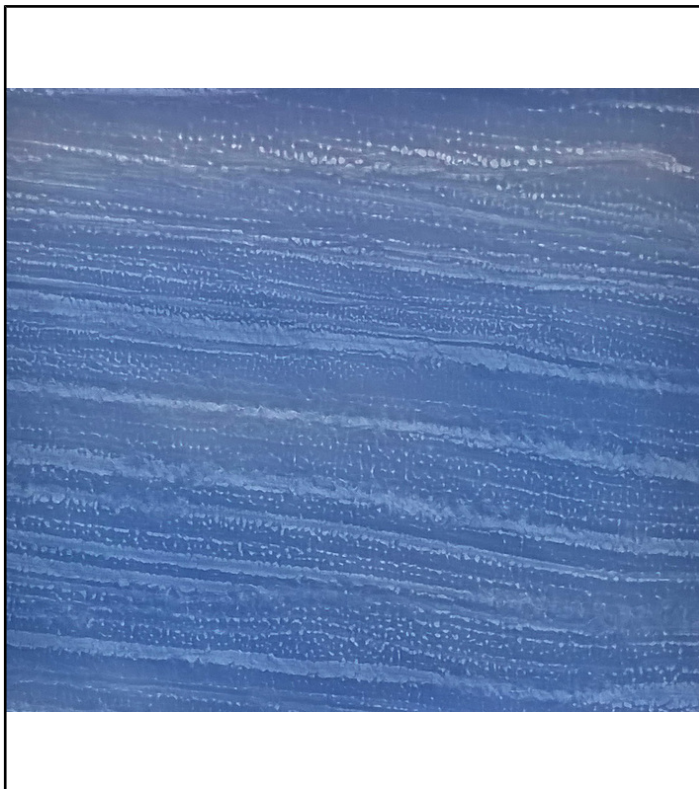
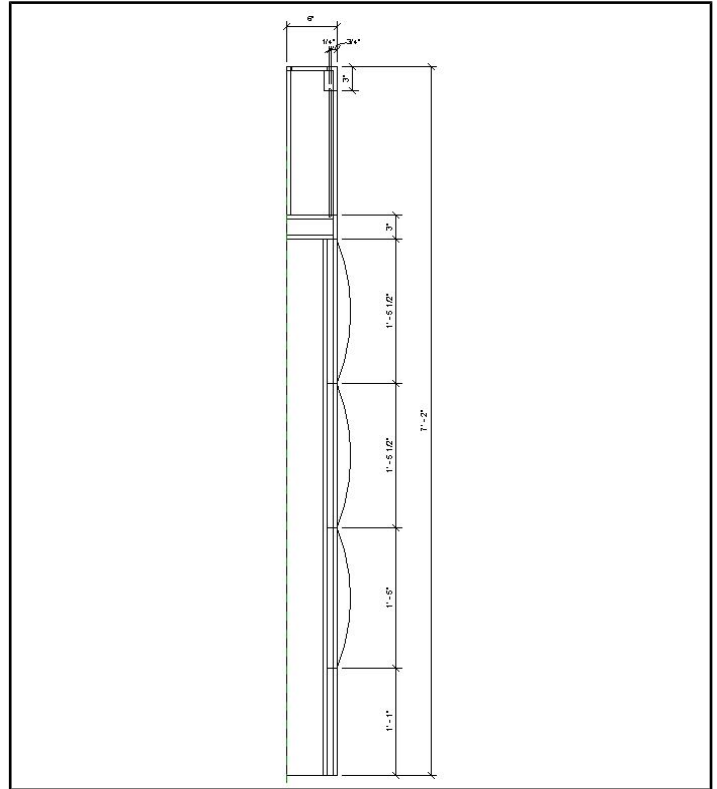
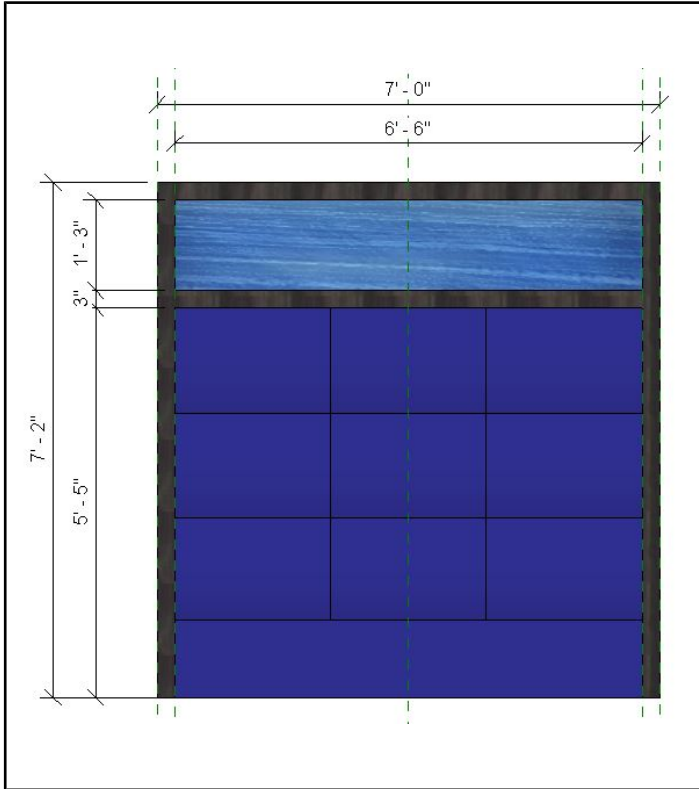



Project:
Project #: 609

Issue Date: 03 FEB 2017
Revision Date:

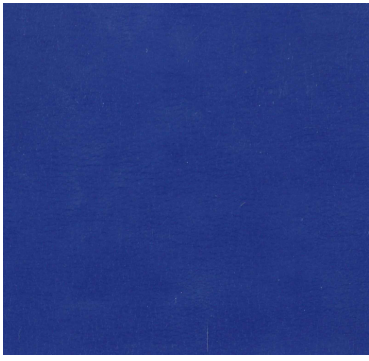
	Upholstery - Refer to F-1.H, King Headboard Fabric		
	Mfr:	Momentum	Qty: 0 Lin Yds
	Pattern:	Custom Silica	
	Color:	Custom	
<hr/>			
INSTRUCTIONS:			



F-1.H

0

Upholstery

Project: -----
Project #: 609

Issue Date: 03 FEB 2017
Revision Date:

Mfr: Momentum
17811 Fitch
Irvine, CA 92614, United States
P: 800.366.6839 F: 949.833.9233
www.themomgroup.com

Rep: Michele Land
United States
mland@momtex.com

Contact: Michele Land
P: 800.366.6839 x845
mland@momtex.com

Contact: Default

BUDGET		REQUIRED FOR APPROVAL	
Lead Time: (weeks)	8-10	<input type="checkbox"/> Cutting	<input checked="" type="checkbox"/>
Bulk Qty:	0 Lin Yds	<input type="checkbox"/> Strike Off	<input checked="" type="checkbox"/>
Area Qty:	0 Lin Yds	<input type="checkbox"/> Cut Sheet	<input checked="" type="checkbox"/>
Total Qty:	0 Lin Yds	<input type="checkbox"/> Flame Certification	<input checked="" type="checkbox"/>
			<input checked="" type="checkbox"/>
			<input type="checkbox"/>

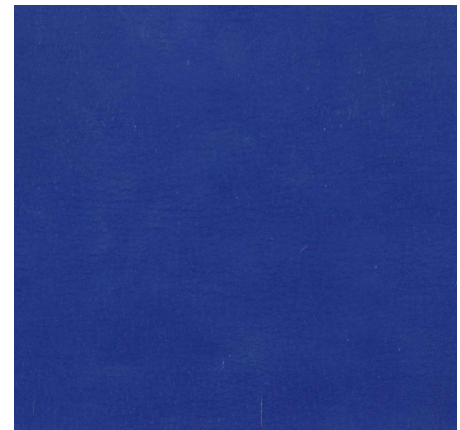

Item Name	King Headboard Fabric
Pattern	Custom Silica
Model #	ML5442-A2
Color	Custom
Content	100% Silicone
Backing	Polyester
Repeat	N/A
Width	54"
Shown Railroaded	No
Finish	N/A
Cleaning Code	WS; Bleach Cleanable (4:1)
Abrasion	365,000 Double Rubs
Flammability	CA Bulletin 117 Sec. E

SPECIAL INSTRUCTIONS:



CG-2.H

Casegoods

Project:
Project #: 609

Issue Date: 03 FEB 2017
Revision Date:

Mfr: HF Collection
465 Forbes Blvd
South San Francisco , CA 94080, United States
P: 650-952-2546 F: 650-952-2681
www.hf-collection.com

Rep: Sarah Turner
United States
P: 650-952-2546 F: 650-952-2681
sarah@hf-collection.com

Contact:

Contact:

Total Qty: 0 Each Area Qty: 0 Each Bulk Qty: 0 Each Lead Time: (weeks) 10-12

Finish Sample Strike-Off Cutting Shop Dwgs Prototype Seaming Diag CAD Drawing Cut Sheet Flame Certification

Item Name	Queen Headboard
Description	Custom Tufted Queen Headboard with Backlit Acrylic Panel
Arcylic Finish	Envel Rice Paper - Weekend Sky
Wood Finish	Stain to match Arborite - W448 LQ
Dimensions	5'-6" L x 4" D x 7'-2" H
Light Box Description	Light Box Panel to be hinged at top along back edge. Light to be mounted on the under side of the hinged top. Nightstand back panels to be coordinated as they will all share a single light strip.
COM	4 yds

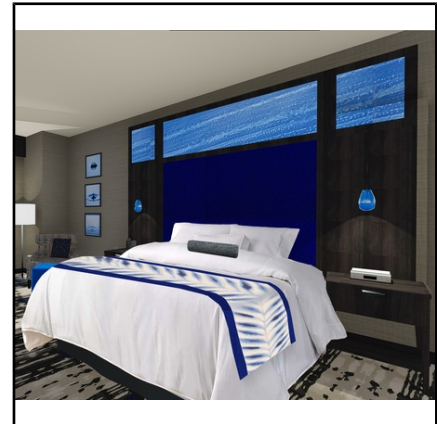

Rendering

SPECIAL INSTRUCTIONS:

1. Please Refer to TBE Standard Construction Standards

AREAS

Project: 609
Project #: 609

Issue Date: 03 FEB 2017
Revision Date:

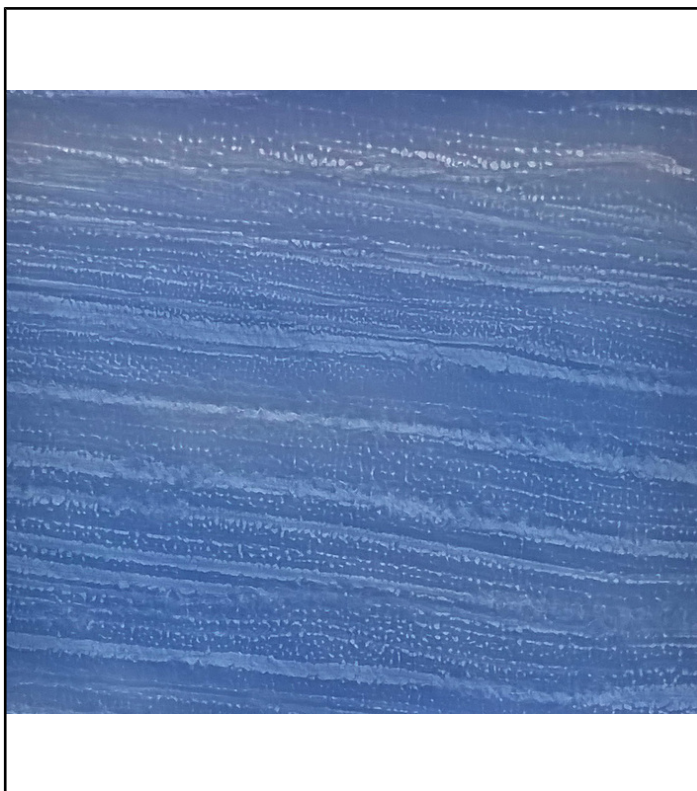
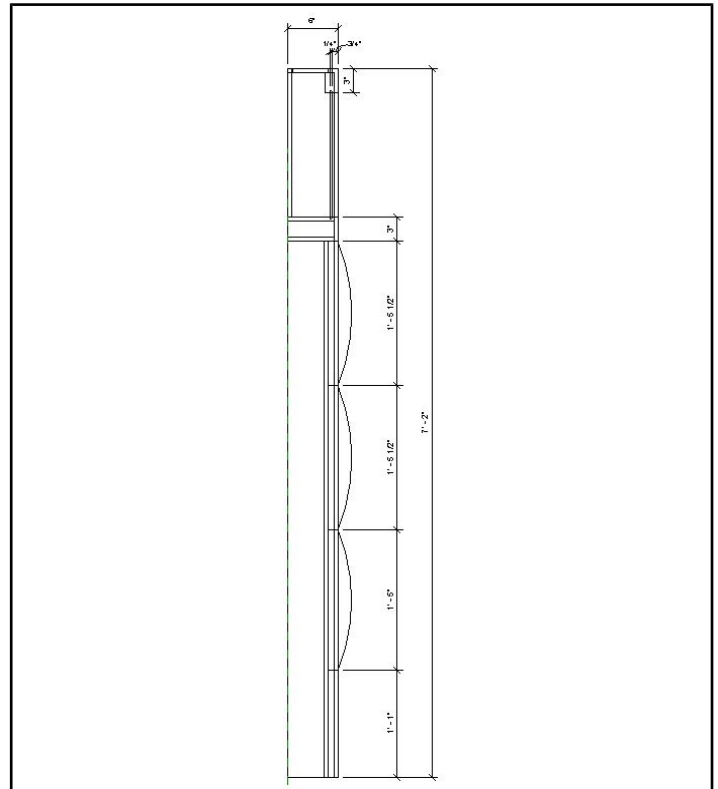
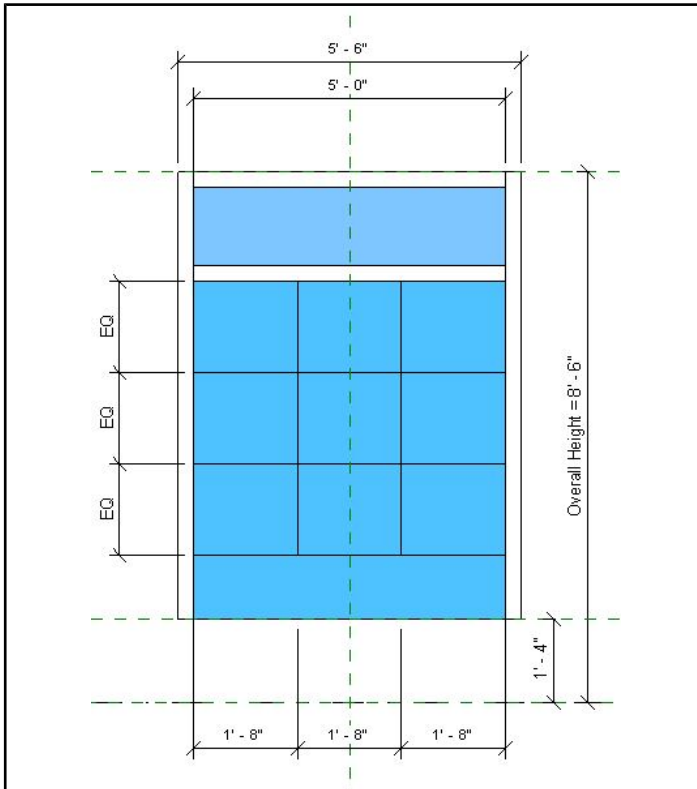



Project:
Project #: 609

Issue Date: 03 FEB 2017
Revision Date:

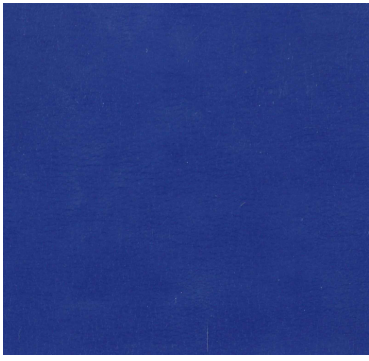
	Upholstery - Refer to F-2.H, Queen Headboard Fabric		
	Mfr:	Momentum	Qty: 0 Lin Yds
	Pattern:	Custom Silica	
	Color:	Custom	
<hr/>			
INSTRUCTIONS:			



F-2.H

0

Upholstery

Project: 609

Issue Date: 03 FEB 2017
Revision Date:

Mfr: Momentum
17811 Fitch
Irvine, CA 92614, United States
P: 800.366.6839 F: 949.833.9233
www.themomgroup.com

Rep: Michele Land
United States
mland@momtex.com

Contact: Michele Land
P: 800.366.6839 x845
mland@momtex.com

Contact: Default

BUDGET		REQUIRED FOR APPROVAL	
Lead Time: (weeks)	8-10	<input type="checkbox"/> Cutting	<input checked="" type="checkbox"/>
Bulk Qty:	0 Lin Yds	<input type="checkbox"/> Strike Off	<input checked="" type="checkbox"/>
Area Qty:	0 Lin Yds	<input type="checkbox"/> Cut Sheet	<input checked="" type="checkbox"/>
Total Qty:	0 Lin Yds	<input type="checkbox"/> Flame Certification	<input checked="" type="checkbox"/>
			<input checked="" type="checkbox"/>
			<input type="checkbox"/>

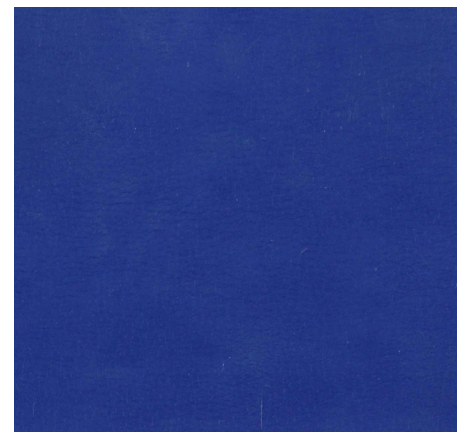

Item Name: Queen Headboard Fabric
 Pattern: Custom Silica
 Model #: ML5442-A2
 Color: Custom
 Content: 100% Silicone
 Backing: Polyester
 Repeat: N/A
 Width: 54"
 Shown Railroaded: No
 Finish: N/A
 Cleaning Code: WS; Bleach Cleanable (4:1)
 Abrasion: 365,000 Double Rubs
 Flammability: CA Bulletin 117 Sec. E

SPECIAL INSTRUCTIONS:

1. Designer to approve strike off sample before order is placed.



CG-3.H

Casegoods

Project: 609

Issue Date: 03 FEB 2017
Revision Date:

Mfr: HF Collection
465 Forbes Blvd
South San Francisco, CA 94080, United States
P: 650-952-2546 F: 650-952-2681
www.hf-collection.com

Rep: Sarah Turner
United States
P: 650-952-2546 F: 650-952-2681
sarah@hf-collection.com

Contact:

Contact:

Total Qty: 0 Each Area Qty: 0 Each Bulk Qty: 0 Each Lead Time: (weeks) 10-12

- Finish Sample
- Strike-Off
- Cutting
- Shop Dwgs
- Prototype
- Seaming Diag
- CAD Drawing
- Cut Sheet
- Flame Certification

Item Name: 24" Nightstand/Panel Combo

Description: Custom 24" Wide Nightstand, Wall panel with integral light box; Plug-ins & Switches included.

Finish: Stain to match Arborite - W448 LQ

Dimensions: 2'-0" W x 9'-0" H

Hardware: Similar to image provided

Solid Surface: Cambria Edinborough Top

Solid Surface Edge Profile: Eased Edge

Solid Surface Thickness: 2CM



Rendering

SPECIAL INSTRUCTIONS:

1. Please Refer to TBE Standard Construction Standards

AREAS

Project:
Project #: 609

Issue Date: 03 FEB 2017
Revision Date:

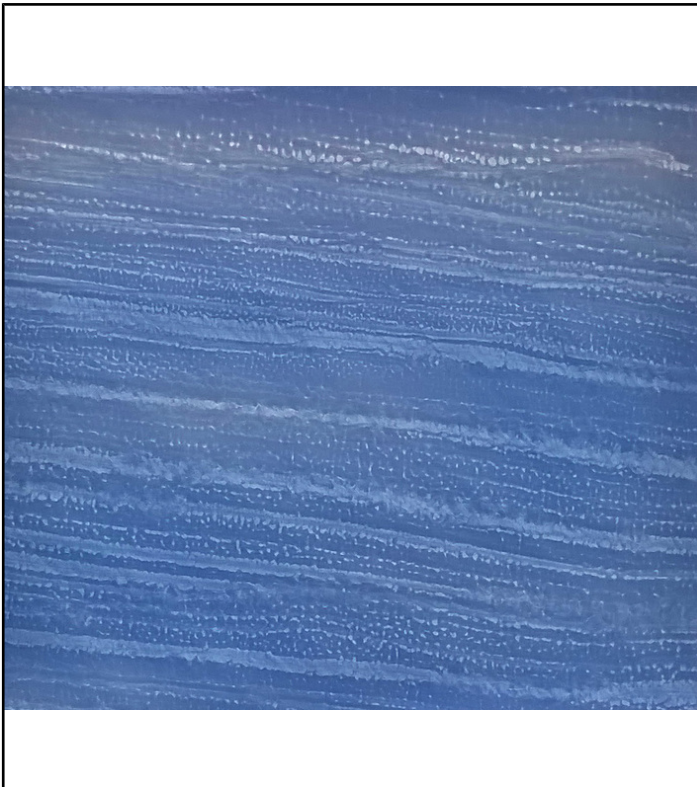
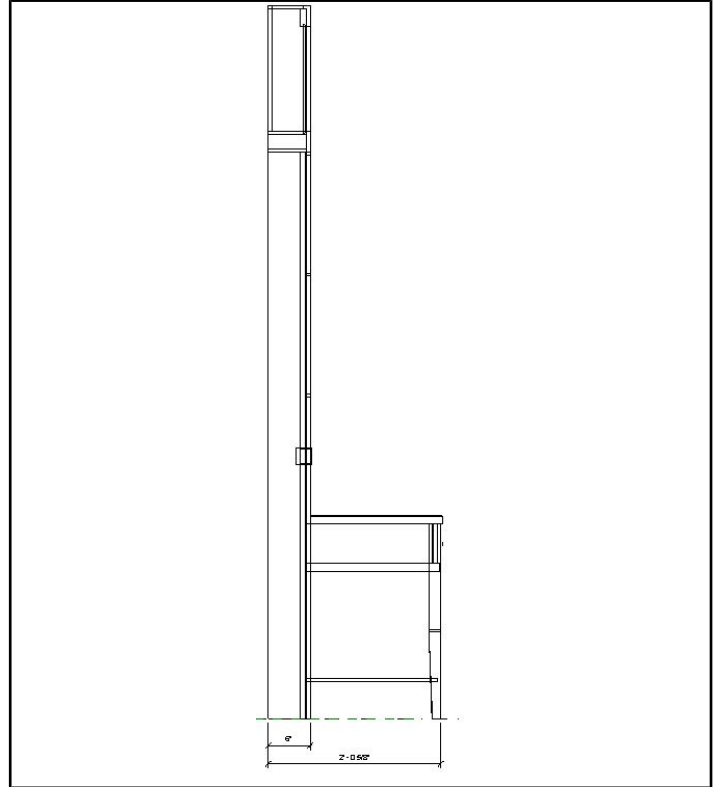



Project: 609

Issue Date: 03 FEB 2017
Revision Date:

Mfr: HF Collection
465 Forbes Blvd
South San Francisco , CA 94080, United States
P: 650-952-2546 F: 650-952-2681
www.hf-collection.com

Rep: Sarah Turner
United States
P: 650-952-2546 F: 650-952-2681
sarah@hf-collection.com

Contact:

Contact:

Total Qty: 0 Each Area Qty: 0 Each Bulk Qty: 0 Each Lead Time: (weeks) 10-12

- Finish Sample
- Strike-Off
- Cutting
- Shop Dwgs
- Prototype
- Seaming Diag
- CAD Drawing
- Cut Sheet
- Flame Certification

Item Name: 30" Nightstand/Panel Combo

Description: Custom 30" Wide Nightstand, Wall panel with integral light box; Plug-ins & Switches included.

Finish: Stain to match Arborite - W448 LQ

Dimensions: 2'-6"W x 9'-0"H

Hardware: Similar to image provided

Solid Surface Top: Cambria Edinborough Top

Solid Surface Edge Profile: Eased Edge

Solid Surface Thickness: 2CM

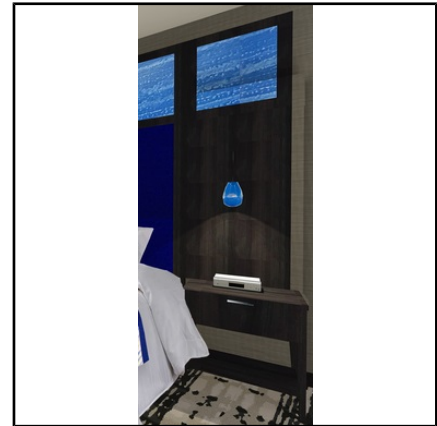

Rendering

SPECIAL INSTRUCTIONS:

1. Please Refer to TBE Standard Construction Standards

AREAS



CG-5.H

Casegoods

Project:
Project #: 609

Issue Date: 03 FEB 2017
Revision Date:

Mfr: HF Collection
465 Forbes Blvd
South San Francisco , CA 94080, United States
P: 650-952-2546 F: 650-952-2681
www.hf-collection.com

Rep: Sarah Turner
United States
P: 650-952-2546 F: 650-952-2681
sarah@hf-collection.com

Contact:

Contact:

Total Qty: 0 Each Area Qty: 0 Each Bulk Qty: 0 Each Lead Time: (weeks) 10-12

- Finish Sample
- Strike-Off
- Cutting
- Shop Dwgs
- Prototype
- Seaming Diag
- CAD Drawing
- Cut Sheet
- Flame Certification

Item Name 36" Nightstand/Panel Combo (ADA)

Description 36" Wide Nightstand, Wall Panel with integral light box; Plug-ins & Switches included.

Finish Stain to match Arborite - W448 LQ

Dimensions 3'-0"W x 9'-0"H

Hardware Similar to image provided

Solid Surface Top Cambria Edinborough Top

Solid Surface Edge Profile Eased Edge

Solid Surface Thickness 2CM

SPECIAL INSTRUCTIONS:

1. Please Refer to TBE Standard Construction Standards

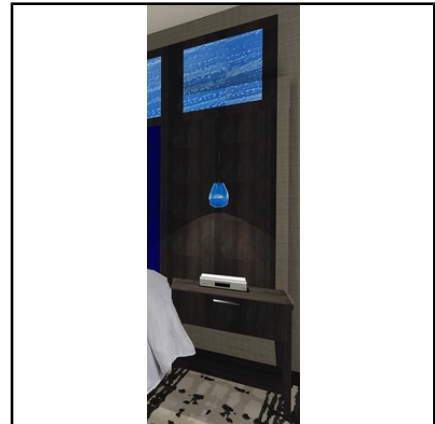

Rendering

AREAS



CG-6.H

Casegoods

Project: 609

Issue Date: 03 FEB 2017
Revision Date:

Mfr: HF Collection
465 Forbes Blvd
South San Francisco, CA 94080, United States
P: 650-952-2546 F: 650-952-2681
www.hf-collection.com

Rep: Sarah Turner
United States
P: 650-952-2546 F: 650-952-2681
sarah@hf-collection.com

Contact:

Contact:

Total Qty: 0 Each Area Qty: 0 Each Bulk Qty: 0 Each Lead Time: (weeks) 10-12

- Finish Sample
- Strike-Off
- Cutting
- Shop Dwgs
- Prototype
- Seaming Diag
- CAD Drawing
- Cut Sheet
- Flame Certification

Item Name	King Bed Base
Description	King Custom Platform for Bed
Laminate	Arborite - W448 LQ
Dimensions	7'-0"W x 7'-4"L x 1'-4"H

SPECIAL INSTRUCTIONS:

1. Please Refer to TBE Standard Construction Standards

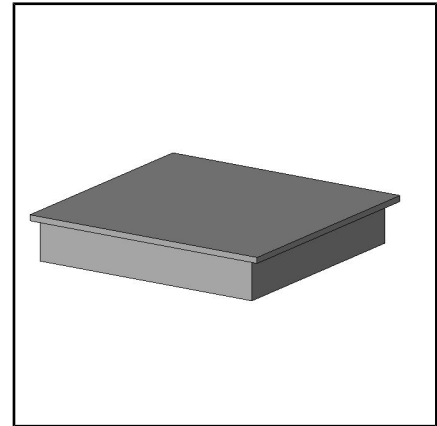

3D View

AREAS



CG-7.H

Casegoods

Project: 609

Issue Date: 03 FEB 2017
Revision Date:

Mfr: HF Collection
465 Forbes Blvd
South San Francisco , CA 94080, United States
P: 650-952-2546 F: 650-952-2681
www.hf-collection.com

Rep: Sarah Turner
United States
P: 650-952-2546 F: 650-952-2681
sarah@hf-collection.com

Contact:

Contact:

Total Qty: 0 Each Area Qty: 0 Each Bulk Qty: 0 Each Lead Time: (weeks) 10-12

- Finish Sample
- Strike-Off
- Cutting
- Shop Dwgs
- Prototype
- Seaming Diag
- CAD Drawing
- Cut Sheet
- Flame Certification

Item Name Queen Bed Base
 Description Queen Custom Platform for Bed
 Finish Stain to match Arborite - W448 LQ
 Dimensions 5'-0"W x 7'-4"L x 1'-4"H

SPECIAL INSTRUCTIONS:

1. Please Refer to TBE Standard Construction Standards

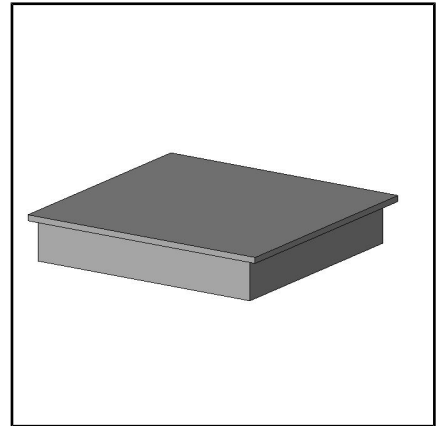

3D View

AREAS



CG-8.H

Casegoods

Project: 609

Issue Date: 03 FEB 2017
Revision Date:

Mfr: HF Collection
465 Forbes Blvd
South San Francisco, CA 94080, United States
P: 650-952-2546 F: 650-952-2681
www.hf-collection.com

Rep: Sarah Turner
United States
P: 650-952-2546 F: 650-952-2681
sarah@hf-collection.com

Contact:

Contact:

Total Qty: 0 Each Area Qty: 0 Each Bulk Qty: 0 Each Lead Time: (weeks) 10-12

- Finish Sample
- Strike-Off
- Cutting
- Shop Dwgs
- Prototype
- Seaming Diag
- CAD Drawing
- Cut Sheet
- Flame Certification

Item Name	Double Queen Power Shelf
Description	Custom floating wall shelf with integral power; Stained to match casegoods
Finish	Stain to match Arborite - W448 LQ
Dimensions	6" W X 10" D X 2.5" OAH
Hardware	Wall mounting brackets
Notes	Provide (2) power ready outlets

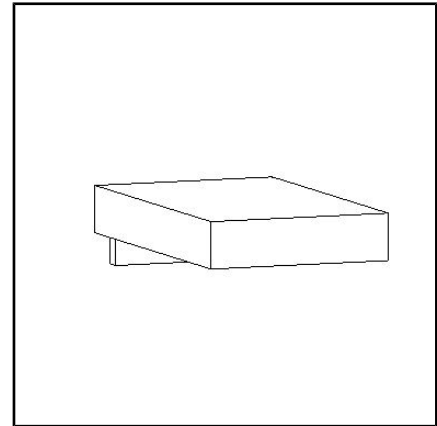

3D View

SPECIAL INSTRUCTIONS:

1. Please Refer to TBE Standard Construction Standards

AREAS



CG-9.H

Revision 1

Casegoods

Project: 609

Issue Date: 03 FEB 2017
Revision Date: 29 NOV 2016 (1)

Mfr: HF Collection
465 Forbes Blvd
South San Francisco, CA 94080, United States
P: 650-952-2546 F: 650-952-2681
www.hf-collection.com

Rep: Sarah Turner
United States
P: 650-952-2546 F: 650-952-2681
sarah@hf-collection.com

Contact:

Contact:

Total Qty: 0 Each Area Qty: 0 Each Bulk Qty: 0 Each Lead Time: (weeks) 10-12

- Finish Sample
- Strike-Off
- Cutting
- Shop Dwgs
- Prototype
- Seaming Diag
- CAD Drawing
- Cut Sheet
- Flame Certification

Item Name	Dresser - 72"W
Description	Custom Six Drawer Dresser
Finish	Stained To Match Arborite W-448 LQ
Dimensions	6'-0"W X 1'-7"D X 2'-6"H
Hardware	Similar to image provided
Drawer Safe	SAFEMARK SYSTEMS DNX 5.4
Solid Surface Top	Cambria Edinborough Top
Solid Surface Edge Profile	Eased Edge
Solid Surface Thickness	2CM

SPECIAL INSTRUCTIONS:

1. Please Refer to TBE Standard Construction Standards



Style

AREAS



CG-10.H

Revision 1

Casegoods

Project:
Project #: 609

Issue Date: 03 FEB 2017
Revision Date: 29 NOV 2016 (1)

Mfr: HF Collection
465 Forbes Blvd
South San Francisco , CA 94080, United States
P: 650-952-2546 F: 650-952-2681
www.hf-collection.com

Rep: Sarah Turner
United States
P: 650-952-2546 F: 650-952-2681
sarah@hf-collection.com

Contact:

Contact:

Total Qty: 0 Each Area Qty: 0 Each Bulk Qty: 0 Each Lead Time: (weeks) 10-12

- Finish Sample
- Strike-Off
- Cutting
- Shop Dwgs
- Prototype
- Seaming Diag
- CAD Drawing
- Cut Sheet
- Flame Certification

Item Name	Dresser - 54"W Suites
Description	Custom Dresser
Finish	Stained To Match Aborite W-448 LQ
Dimensions	4'-6"W X 1'-7"D X 2'-6"H
Hardware	Similar to image provided
Drawer Safe	SAFEMARK SYSTEMS DNX 5.4
Solid Surface Top	Cambria Edinborough Top
Solid Surface Edge Profile	Eased Edge
Solid Surface Thickness	2CM

SPECIAL INSTRUCTIONS:

1. Please Refer to TBE Standard Construction Standards



Style

AREAS



CG-11.H

Revision 1

Casegoods

Project: 609

Issue Date: 03 FEB 2017
Revision Date: 29 NOV 2016 (1)

Mfr: HF Collection
465 Forbes Blvd
South San Francisco , CA 94080, United States
P: 650-952-2546 F: 650-952-2681
www.hf-collection.com

Rep: Sarah Turner
United States
P: 650-952-2546 F: 650-952-2681
sarah@hf-collection.com

Contact:

Contact:

Total Qty: 0 Each Area Qty: 0 Each Bulk Qty: 0 Each Lead Time: (weeks) 10-12

- Finish Sample
- Strike-Off
- Cutting
- Shop Dwgs
- Prototype
- Seaming Diag
- CAD Drawing
- Cut Sheet
- Flame Certification

Item Name	Desk LH - 48"W
Description	Custom Cantilevered Desk
Finish	Stained To Match Aborite W-448 LQ
Dimensions	4'-0"W X 1'-7"D X 34"OAH
Hardware	Similar to image provided
Solid Surface Top	Cambria Edinborough Top
Solid Surface Edge Profile	Eased Edge
Solid Surface Thickness	2CM

SPECIAL INSTRUCTIONS:

1. Please Refer to TBE Standard Construction Standards



AREAS



CG-12.H

Revision 1

Casegoods

Project: 609

Issue Date: 03 FEB 2017
Revision Date: 29 NOV 2016 (1)

Mfr: HF Collection
465 Forbes Blvd
South San Francisco, CA 94080, United States
P: 650-952-2546 F: 650-952-2681
www.hf-collection.com

Rep: Sarah Turner
United States
P: 650-952-2546 F: 650-952-2681
sarah@hf-collection.com

Contact:

Contact:

Total Qty: 0 Each Area Qty: 0 Each Bulk Qty: 0 Each Lead Time: (weeks) 10-12

- Finish Sample
- Strike-Off
- Cutting
- Shop Dwgs
- Prototype
- Seaming Diag
- CAD Drawing
- Cut Sheet
- Flame Certification

Item Name	Desk RH - 48"W
Description	Custom Cantilever Desk; Right-Hand;
Finish	Stained To Match Aborite W-448 LQ
Dimensions	4'-0"W X 1'-7"D X 34"OAH
Hardware	Similar to image provided
Solid Surface Top	Cambria Edinborough Top
Solid Surface Edge Profile	Eased Edge
Solid Surface Thickness	2CM

SPECIAL INSTRUCTIONS:

1. Please Refer to TBE Standard Construction Standards



Style

AREAS



CG-14.H

Casegoods

Project:
Project #: 609

Issue Date: 03 FEB 2017
Revision Date:

Mfr: HF Collection
465 Forbes Blvd
South San Francisco , CA 94080, United States
P: 650-952-2546 F: 650-952-2681
www.hf-collection.com

Rep: Sarah Turner
United States
P: 650-952-2546 F: 650-952-2681
sarah@hf-collection.com

Contact:

Contact:

Total Qty: 0 Each Area Qty: 0 Each Bulk Qty: 0 Each Lead Time: (weeks) 10-12

- Finish Sample
- Strike-Off
- Cutting
- Shop Dwgs
- Prototype
- Seaming Diag
- CAD Drawing
- Cut Sheet
- Flame Certification

Item Name	TV Wall Panel
Description	Custom TV Wall Panel
Finish	Stained To Match Aborite W-448 LQ
Dimensions	TBD, based on client's TV Specification
Hardware	Provide wall mounted security brackets, TV supports and power connection

SPECIAL INSTRUCTIONS:

- Please Refer to TBE Standard Construction Standards



Style

AREAS



CG-15.H

Casegoods

Project:
Project #: 609

Issue Date: 03 FEB 2017
Revision Date:

Mfr: Shelby Williams
810 West Hwy 25/70
Newport, TN 37821, United States
P: 800-873-3252 F: 866-900-0938
www.shelbywilliams.com

Rep: Don Karrer
339 Wind Grove
St. Louis, MO 63122, United States
P: 314-749-8128 F: 314-394-2330
dwkarrer@aol.com

Contact:

Contact:

Total Qty: 0 Area Qty: 0 Bulk Qty: 0 Lead Time: (weeks)

- Finish Sample
- Strike-Off
- Cutting
- Shop Dwgs
- Prototype
- Seaming Diag
- CAD Drawing
- Cut Sheet
- Flame Certification

Item Name	Dining Table - 36" Diameter
Description	Wood Column, Cast Iron Base, RCT Glides
Model #	69A5 Series Table Base
Finish	WBF154 Black
Dimensions	36" table top
Base	22
Top	Cambria - Berwyn
Edge Profile	Eased Edge
Top Thickness	2CM
Legs/Feet	Nylon Glides



For reference only

SPECIAL INSTRUCTIONS:

1. Please Refer to TBE Standard Construction Standards

AREAS



Project: 609

Issue Date: 03 FEB 2017
Revision Date:

Mfr: D'Style
3451 Main Street, Suite 108,
Chula Vista, CA 91911, United States
P: 619-662-0560 F: 619-662-3388
<http://www.dstyleinc.com>

Rep: Cory Weber
United States
P: 314-583-0548
Email: cweb1212@charter.net

Contact:

Contact:

Total Qty: 0 Each Area Qty: 0 Each Bulk Qty: 0 Each Lead Time: (weeks) 10-12

- Finish Sample
- Strike-Off
- Cutting
- Shop Dwgs
- Prototype
- Seaming Diag
- CAD Drawing
- Cut Sheet
- Flame Certification

Item Name	Double Queen Occasional Table
Description	Custom Round Occasional Table with Metal Frame
Finish	Metal TBD
Dimensions	24" Diameter x 24" Height
Base	Nylon Glides
Solid Surface Top and Bottom Shelf	Cambria Berwyn

SPECIAL INSTRUCTIONS:

- Please Refer to TBE Standard Construction Standards



Table top to be solid surface, not glass

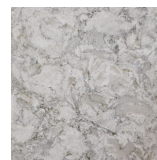

Solid Surface Table Top and Bottom Shelf

AREAS



CG-18.H

Casegoods

Project: 609

Issue Date: 03 FEB 2017
Revision Date:

Mfr: Kellex Seating
33390 Liberty Parkway
North Ridgeville, OH 44039, United States
P: 440-327-4428
www.kellex.com

Rep: Susan Faulhaber
715 Briar Fork Rd.
Des Peres, MO 63131, United States
P: 314-909-7172 F: 314-909-7173
susie_faulhaber@sbcglobal.net

Contact:

Contact:

Total Qty: 0 Area Qty: 0 Bulk Qty: 0 Lead Time: (weeks)

- Finish Sample
- Strike-Off
- Cutting
- Shop Dwgs
- Prototype
- Seaming Diag
- CAD Drawing
- Cut Sheet
- Flame Certification

Item Name	Activity Table 30" Dia.
Description	30" Diameter Activity Table
Finish	E-2 Silvertone
Dimensions	30" Diameter Table Top x 30" Overall Height
Hardware	
Top	Cambria - Berwyn
Edge Profile	Eased Edge
Top Thickness	2 CM
Legs/Feet	Nylon Glides



Style

SPECIAL INSTRUCTIONS:

1. Please Refer to TBE Standard Construction Standards

AREAS



CG-21.H

Casegoods

Project: 609

Issue Date: 03 FEB 2017
Revision Date:

Mfr: HF Collection
465 Forbes Blvd
South San Francisco, CA 94080, United States
P: 650-952-2546 F: 650-952-2681
www.hf-collection.com

Rep: Sarah Turner
United States
P: 650-952-2546 F: 650-952-2681
sarah@hf-collection.com

Contact:

Contact:

Total Qty: 0 Each Area Qty: 0 Each Bulk Qty: 0 Each Lead Time: (weeks) 16-18

- Finish Sample
- Strike-Off
- Cutting
- Shop Dwgs
- Prototype
- Seaming Diag
- CAD Drawing
- Cut Sheet
- Flame Certification

Item Name: Typical Guestroom Vanity
 Description: Freestanding Wood Vanity with Lower Shelf & Solid Surface Top
 Model #: TBD
 Frame Finish: Stain To Match Arborite W448 LQ
 Top: Cambria Berwyn
 Top Thickness: 2 CM
 Dimensions: 72"L X 24"D X 34"OH
 Hardware: 10"H Brushed Stainless Metal Ferrules on all 4 Legs
 Sink Style: Undermount
 Faucet Style: Single Hole

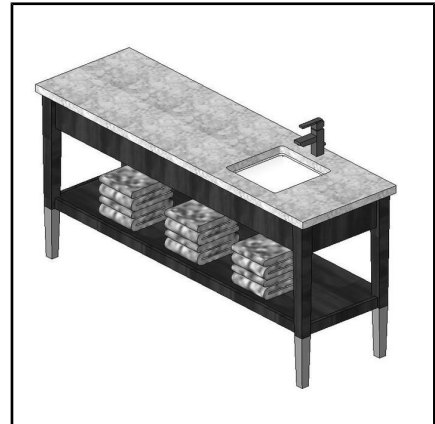

SPECIAL INSTRUCTIONS:

1. Please Refer to TBE Standard Construction Standards
2. All Lumber/Joinery/Hardware/Finishing to Comply with AWI Standards for Vanities in Damp Locations
3. Refer to Cutsheets on Client Approved Sink & Faucet for Cutout Dimensions

AREAS



Project:
Project #: 609

Issue Date: 03 FEB 2017
Revision Date:

Mfr: D'Style
3451 Main Street, Suite 108,
Chula Vista, CA 91911, United States
P: 619-662-0560 F: 619-662-3388
<http://www.dstyleinc.com>

Rep: Cory Weber
United States
P: 314-583-0548
Email: cweb1212@charter.net

Contact:

Contact:

Total Qty: 10 Each Area Qty: 0 Each Bulk Qty: 10 Each Lead Time: (weeks) 10-12

- Finish Sample
- Strike-Off
- Cutting
- Shop Dwgs
- Prototype
- Seaming Diag
- CAD Drawing
- Cut Sheet
- Flame Certification

Item Name Hotel Tower Elevator Lobby Console Table
 Description Andy Console Table
 Model # ACD-3308-03
 Finish Black on Oak
 Dimensions 50"L X 20"W X 30"H

SPECIAL INSTRUCTIONS:
 1. To be Ordered with Glass Top



AREAS



CG-23.H

Casegoods

Project:
Project #: 609

Issue Date: 03 FEB 2017
Revision Date:

Mfr: HF Collection
465 Forbes Blvd
South San Francisco , CA 94080, United States
P: 650-952-2546 F: 650-952-2681
www.hf-collection.com

Rep: Sarah Turner
United States
P: 650-952-2546 F: 650-952-2681
sarah@hf-collection.com

Contact:

Contact:

Total Qty: 0 Each Area Qty: 0 Each Bulk Qty: 0 Each Lead Time: (weeks)

- Finish Sample
- Strike-Off
- Cutting
- Shop Dwgs
- Prototype
- Seaming Diag
- CAD Drawing
- Cut Sheet
- Flame Certification

Item Name: Suites Console Table
 Description: Waterfall Console
 Finish: Stained to Match Arborite W-448 LQ
 Dimensions: 1'-10"D X 5'-0"W X 30"H
 Solid Surface Top: Cambria Edinborough Top
 Solid Surface Edge Profile: Eased Edge
 Solid Surface Thickness: 2CM
 SPECIAL INSTRUCTIONS:



AREAS



CG-25.H

Revision 1

Casegoods

Project: 609

Issue Date: 03 FEB 2017
Revision Date: 20 DEC 2016 (1)

Mfr: HF Collection
465 Forbes Blvd
South San Francisco, CA 94080, United States
P: 650-952-2546 F: 650-952-2681
www.hf-collection.com

Rep: Sarah Turner
United States
P: 650-952-2546 F: 650-952-2681
sarah@hf-collection.com

Contact:

Contact:

Total Qty: 0 Each Area Qty: 0 Each Bulk Qty: 0 Each Lead Time: (weeks) 16-18

- Finish Sample
- Strike-Off
- Cutting
- Shop Dwgs
- Prototype
- Seaming Diag
- CAD Drawing
- Cut Sheet
- Flame Certification

Item Name: Accessible Guestroom Vanity
 Item Name: Typical ADA Vanity
 Model #: TBD
 Description: Wall Mounted Vanity with Solid Surface & Wood Apron
 Apron Finish: Stain to Match Arborite W448 LQ
 Top: Cambria Berwyn
 Top Thickness: 2 CM
 Dimensions: 3'-3"W X 2'-0"D; 5"H Apron
 Sink Style: Undermount
 Faucet Style: Single Hole

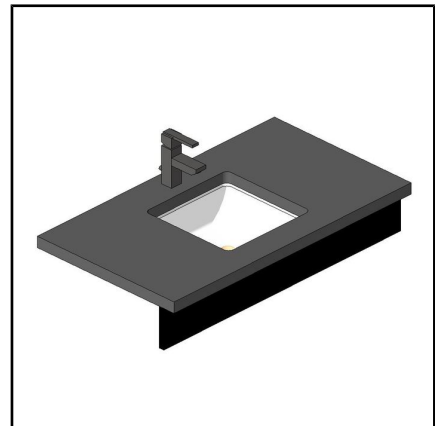

SPECIAL INSTRUCTIONS:

1. Insulation Kits to Be Provided for P-Trap and Waterlines per Requirements for ADA Vanities
2. Please Refer to TBE Standard Construction Standards
3. All Lumber/Joinery/Hardware/Finishing to Comply with AWI Standards for Vanities in Damp Locations
4. Refer to Cutsheets on Client Approved Sink & Faucet for Cutout Dimensions

AREAS



CG-26.H

Revision 1

Casegoods

Project:
Project #: 609

Issue Date: 03 FEB 2017
Revision Date: 20 DEC 2016 (1)

Mfr: HF Collection
465 Forbes Blvd
South San Francisco, CA 94080, United States
P: 650-952-2546 F: 650-952-2681
www.hf-collection.com

Rep: Sarah Turner
United States
P: 650-952-2546 F: 650-952-2681
sarah@hf-collection.com

Contact:

Contact:

Total Qty: 0 Each Area Qty: 0 Each Bulk Qty: 0 Each Lead Time: (weeks) 16-18

- Finish Sample
- Strike-Off
- Cutting
- Shop Dwgs
- Prototype
- Seaming Diag
- CAD Drawing
- Cut Sheet
- Flame Certification

Item Name 2 Room Suite Accessible Guestroom Vanity
 Item Name ADA Vanity - Front & Side Apron
 Model # TBD
 Description Wall Mounted Vanity with Solid Surface &
 Wood Apron
 Apron Finish Stain to Match Arborite W448 LQ
 Top Cambria Berwyn
 Top Thickness 2 CM
 Dimensions 3'-3"W X 2'-0"D; 5"H Apron
 Sink Style Undermount
 Faucet Style Single Hole

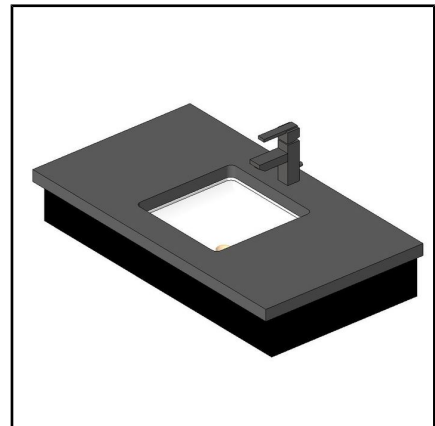

SPECIAL INSTRUCTIONS:

1. Heavy Duty Wall Angle Support Must be Provided on Non-Wall Side
2. Insulation Kits to Be Provided for P-Trap and Waterlines per Requirements for ADA Vanities
3. Please Refer to TBE Standard Construction Standards
4. All Lumber/Joinery/Hardware/Finishing to Comply with AWI Standards for Vanities in Damp Locations
5. Refer to Cutsheets on Client Approved Sink & Faucet for Cutout Dimensions

AREAS



CG-27.H

Casegoods

Project: 609

Issue Date: 03 FEB 2017
Revision Date:

Mfr: HF Collection
465 Forbes Blvd
South San Francisco, CA 94080, United States
P: 650-952-2546 F: 650-952-2681
www.hf-collection.com

Rep: Sarah Turner
United States
P: 650-952-2546 F: 650-952-2681
sarah@hf-collection.com

Contact:

Contact:

Total Qty: 0 Each Area Qty: 0 Each Bulk Qty: 0 Each Lead Time: (weeks) 16-18

- Finish Sample
- Strike-Off
- Cutting
- Shop Dwgs
- Prototype
- Seaming Diag
- CAD Drawing
- Cut Sheet
- Flame Certification

Item Name: Guestroom Vanity - 5'

Description: Freestanding Wood Vanity with Lower Shelf & Solid Surface Top

Model #: TBD

Frame Finish: Stain To Match Arborite W448 LQ

Top: Cambria Berwyn

Top Thickness: 2 CM

Dimensions: 60"L X 24"D X 34"OH

Hardware: 10"H Brushed Stainless Metal Ferrules on all 4 Legs

Sink Style: Undermount

Faucet Style: Single Hole

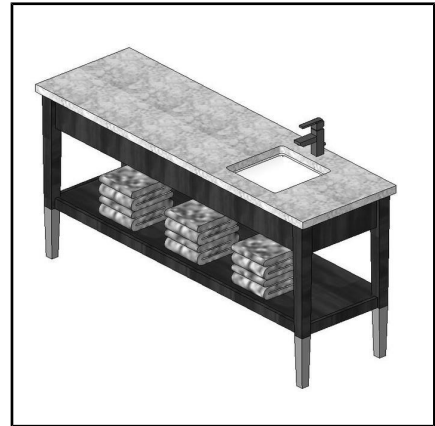

SPECIAL INSTRUCTIONS:

1. Please Refer to TBE Standard Construction Standards
2. All Lumber/Joinery/Hardware/Finishing to Comply with AWI Standards for Vanities in Damp Locations
3. Refer to Cutsheets on Client Approved Sink & Faucet for Cutout Dimensions

AREAS



Project: 609

Issue Date: 03 FEB 2017
Revision Date:

Mfr: HF Collection
465 Forbes Blvd
South San Francisco , CA 94080, United States
P: 650-952-2546 F: 650-952-2681
www.hf-collection.com

Rep: Sarah Turner
United States
P: 650-952-2546 F: 650-952-2681
sarah@hf-collection.com

Contact:

Contact:

Total Qty: 0 Each Area Qty: 0 Each Bulk Qty: 0 Each Lead Time: (weeks) 16-18

- Finish Sample
- Strike-Off
- Cutting
- Shop Dwgs
- Prototype
- Seaming Diag
- CAD Drawing
- Cut Sheet
- Flame Certification

Item Name: 2 Room Suites Vanity - Angled Top
 Description: Angled Freestanding Wood Vanity with Lower Shelf & Solid Surface Top
 Model #: TBD
 Frame Finish: Stain To Match Arborite W448 LQ
 Top: Cambria Berwyn
 Top Thickness: 2 CM
 Dimensions: SEE ARCHITECTURAL PLANS
 Hardware: 10"H Brushed Stainless Metal Ferrules on all 4 Legs
 Sink Style: Undermount
 Faucet Style: Single Hole

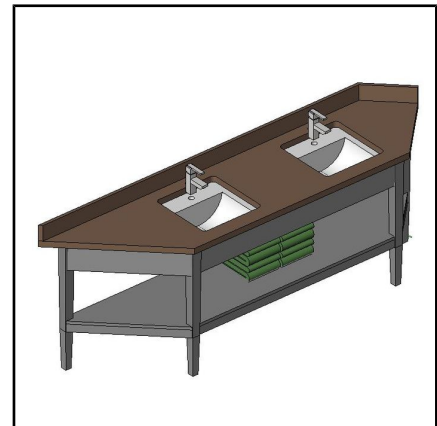

SPECIAL INSTRUCTIONS:

1. Please Refer to TBE Standard Construction Standards
2. All Lumber/Joinery/Hardware/Finishing to Comply with AWI Standards for Vanities in Damp Locations
3. Refer to Cutsheets on Client Approved Sink & Faucet for Cutout Dimensions

AREAS



Project: 609

Issue Date: 03 FEB 2017
Revision Date:

Mfr: HF Collection
465 Forbes Blvd
South San Francisco, CA 94080, United States
P: 650-952-2546 F: 650-952-2681
www.hf-collection.com

Rep: Sarah Turner
United States
P: 650-952-2546 F: 650-952-2681
sarah@hf-collection.com

Contact:

Contact:

Total Qty: 0 Each Area Qty: 0 Each Bulk Qty: 0 Each Lead Time: (weeks) 16-18

- Finish Sample
- Strike-Off
- Cutting
- Shop Dwgs
- Prototype
- Seaming Diag
- CAD Drawing
- Cut Sheet
- Flame Certification

Item Name: 2 Room Suites Powder Room Vanity
 Description: Freestanding Wood Vanity with Lower Shelf & Solid Surface Top
 Model #: TBD
 Frame Finish: Stain To Match Arborite W448 LQ
 Top: Cambria Berwyn
 Top Thickness: 2 CM
 Dimensions: 48"W X 24"D X 34" OAH
 Hardware: 10"H Brushed Stainless Metal Ferrules on all 4 Legs
 Sink Style: Undermount
 Faucet Style: Single Hole

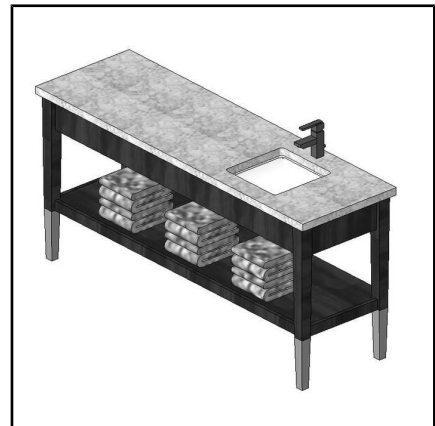

SPECIAL INSTRUCTIONS:

1. Please Refer to TBE Standard Construction Standards
2. All Lumber/Joinery/Hardware/Finishing to Comply with AWI Standards for Vanities in Damp Locations
3. Refer to Cutsheets on Client Approved Sink & Faucet for Cutout Dimensions

AREAS



CG-30.H

Casegoods

Project: 609

Issue Date: 03 FEB 2017
Revision Date:

Mfr: HF Collection
465 Forbes Blvd
South San Francisco, CA 94080, United States
P: 650-952-2546 F: 650-952-2681
www.hf-collection.com

Rep: Sarah Turner
United States
P: 650-952-2546 F: 650-952-2681
sarah@hf-collection.com

Contact:

Contact:

Total Qty: 0 Each Area Qty: 0 Each Bulk Qty: 0 Each Lead Time: (weeks) 16-18

- Finish Sample
- Strike-Off
- Cutting
- Shop Dwgs
- Prototype
- Seaming Diag
- CAD Drawing
- Cut Sheet
- Flame Certification

Item Name	Refrigerator Drybar with LH Panel
Description	Freestanding Refrigerator Cabinet with Solid Surface Waterfall Side and LH Decorative Screen Panel
Model #	TBD
Cabinet & Panel Finish	Stain To Match Arborite W448 LQ
Waterfall Top & Side	Cambria Berwyn
Top Thickness	Varies - SEE SHOP DRAWINGS
Acrylic Panel for Screen	Envel Rice Paper - Weekend Sky
Dimensions	2'-8"W X 8'-6"H X 2'-1/2"D; 2'-10"H to Top Counter
Hardware	TBD

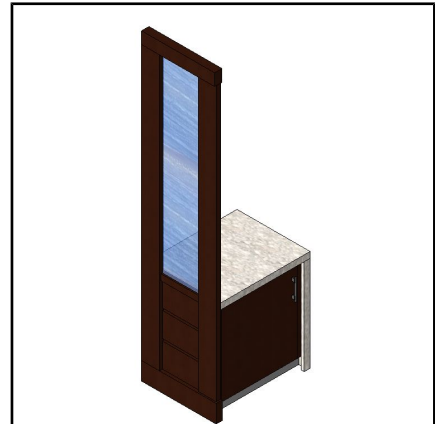

SPECIAL INSTRUCTIONS:

1. Please Refer to TBE Standard Construction Standards
2. All Lumber/Joinery/Hardware/Finishing to Comply with AWI Standards for Vanities in Damp Locations

AREAS



CG-31.H

Casegoods

Project: 609

Issue Date: 03 FEB 2017
Revision Date:

Mfr: HF Collection
465 Forbes Blvd
South San Francisco, CA 94080, United States
P: 650-952-2546 F: 650-952-2681
www.hf-collection.com

Rep: Sarah Turner
United States
P: 650-952-2546 F: 650-952-2681
sarah@hf-collection.com

Contact:

Contact:

Total Qty: 0 Each Area Qty: 0 Each Bulk Qty: 0 Each Lead Time: (weeks) 16-18

- Finish Sample
- Strike-Off
- Cutting
- Shop Dwgs
- Prototype
- Seaming Diag
- CAD Drawing
- Cut Sheet
- Flame Certification

Item Name	Refrigerator Drybar with RH Panel
Description	Freestanding Refrigerator Cabinet with Solid Surface Waterfall Side and RH Decorative Screen Panel
Model #	TBD
Cabinet & Panel Finish	Stain To Match Arborite W448 LQ
Waterfall Top & Side	Cambria Berwyn
Top Thickness	Varies - SEE SHOP DRAWINGS
Acrylic Panel for Screen	Envel Rice Paper - Weekend Sky
Dimensions	2'-8"W X 8'-6"H X 2'-1/2"D; 2'-10"H to Top Counter
Hardware	TBD

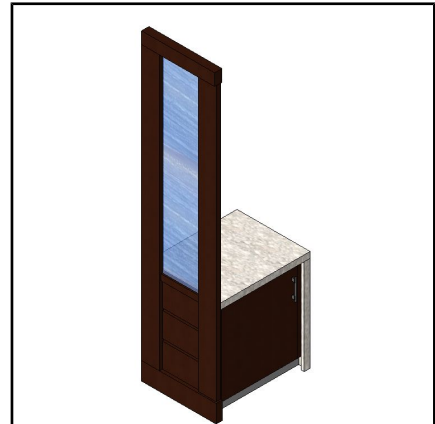

SPECIAL INSTRUCTIONS:

1. Please Refer to TBE Standard Construction Standards
2. All Lumber/Joinery/Hardware/Finishing to Comply with AWI Standards for Vanities in Damp Locations

AREAS



CG-32.H

Casegoods

Project: 609

Issue Date: 03 FEB 2017
Revision Date:

Mfr: HF Collection
465 Forbes Blvd
South San Francisco, CA 94080, United States
P: 650-952-2546 F: 650-952-2681
www.hf-collection.com

Rep: Sarah Turner
United States
P: 650-952-2546 F: 650-952-2681
sarah@hf-collection.com

Contact:

Contact:

Total Qty: 0 Each Area Qty: 0 Each Bulk Qty: 0 Each Lead Time: (weeks) 16-18

- Finish Sample
- Strike-Off
- Cutting
- Shop Dwgs
- Prototype
- Seaming Diag
- CAD Drawing
- Cut Sheet
- Flame Certification

Item Name: Refrigerator Drybar with LH Waterfall - No Panel

Description: Freestanding Refrigerator Cabinet with Solid Surface LH Waterfall

Model #: TBD

Cabinet & Panel Finish: Stain To Match Arborite W448 LQ

Waterfall Top & Side: Cambria Berwyn

Top Thickness: Varies - SEE SHOP DRAWINGS

Dimensions: 2'-6"W X 2'-10"H X 2'-1/2"D

Hardware: TBD

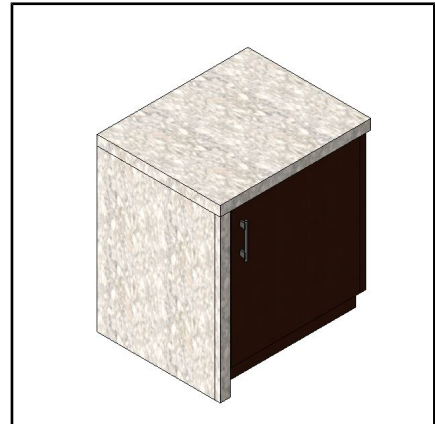

SPECIAL INSTRUCTIONS:

1. Please Refer to TBE Standard Construction Standards
2. All Lumber/Joinery/Hardware/Finishing to Comply with AWI Standards for Vanities in Damp Locations

AREAS



CG-33.H

Casegoods

Project: 609

Issue Date: 03 FEB 2017
Revision Date:

Mfr: HF Collection
465 Forbes Blvd
South San Francisco , CA 94080, United States
P: 650-952-2546 F: 650-952-2681
www.hf-collection.com

Rep: Sarah Turner
United States
P: 650-952-2546 F: 650-952-2681
sarah@hf-collection.com

Contact:

Contact:

Total Qty: 0 Each Area Qty: 0 Each Bulk Qty: 0 Each Lead Time: (weeks) 16-18

- Finish Sample
- Strike-Off
- Cutting
- Shop Dwgs
- Prototype
- Seaming Diag
- CAD Drawing
- Cut Sheet
- Flame Certification

Item Name: Refrigerator Drybar with RH Waterfall - No Panel

Description: Freestanding Refrigerator Cabinet with Solid Surface RH Waterfall

Model #: TBD

Cabinet & Panel Finish: Stain To Match Arborite W448 LQ

Waterfall Top & Side: Cambria Berwyn

Top Thickness: Varies - SEE SHOP DRAWINGS

Dimensions: 2'-6"W X 2'-10"H X 2'-1/2"D

Hardware: TBD

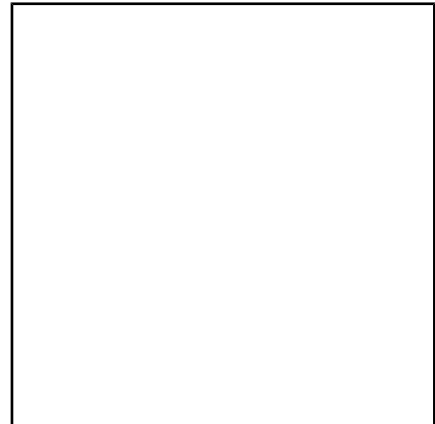

SPECIAL INSTRUCTIONS:

1. Please Refer to TBE Standard Construction Standards
2. All Lumber/Joinery/Hardware/Finishing to Comply with AWI Standards for Vanities in Damp Locations

AREAS



CG-34.H

Casegoods

Project:
Project #: 609

Issue Date: 03 FEB 2017
Revision Date:

Mfr: HF Collection
465 Forbes Blvd
South San Francisco , CA 94080, United States
P: 650-952-2546 F: 650-952-2681
www.hf-collection.com

Rep: Sarah Turner
United States
P: 650-952-2546 F: 650-952-2681
sarah@hf-collection.com

Contact:

Contact:

Total Qty: 0 Each Area Qty: 0 Each Bulk Qty: 0 Each Lead Time: (weeks) 16-18

Finish Sample Strike-Off Cutting Shop Dwgs Prototype Seaming Diag CAD Drawing Cut Sheet Flame Certification

Item Name	Refrigerator Drybar - No Waterfall or Panel
Description	Freestanding Refrigerator Cabinet with Solid Surface RH Waterfall
Model #	TBD
Cabinet & Panel Finish	Stain To Match Arborite W448 LQ
Waterfall Top & Side	Cambria Berwyn
Top Thickness	Varies - SEE SHOP DRAWINGS
Dimensions	2'-1"W X 2'-1/2"D X 2'-10"H
Hardware	TBD

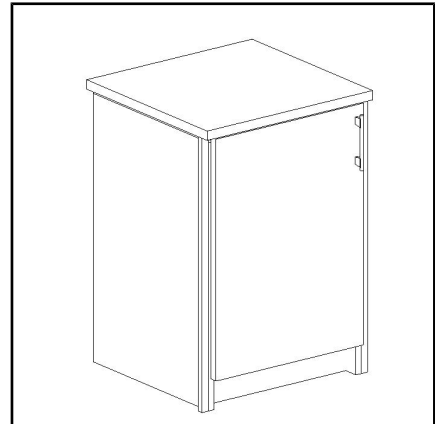

SPECIAL INSTRUCTIONS:

1. Please Refer to TBE Standard Construction Standards
2. All Lumber/Joinery/Hardware/Finishing to Comply with AWI Standards for Vanities in Damp Locations

AREAS



CG-35.H

Casegoods

Project:
Project #: 609

Issue Date: 03 FEB 2017
Revision Date:

Mfr: HF Collection
465 Forbes Blvd
South San Francisco , CA 94080, United States
P: 650-952-2546 F: 650-952-2681
www.hf-collection.com

Rep: Sarah Turner
United States
P: 650-952-2546 F: 650-952-2681
sarah@hf-collection.com

Contact:

Contact:

Total Qty: 0 Each Area Qty: 0 Each Bulk Qty: 0 Each Lead Time: (weeks) 16-18

- Finish Sample
- Strike-Off
- Cutting
- Shop Dwgs
- Prototype
- Seaming Diag
- CAD Drawing
- Cut Sheet
- Flame Certification

Item Name 2 Room Suite Drybar
 Description Drybar with Refrigerator Cabinet
 Model # TBD
 Cabinet & Panel Finish Stain To Match Arborite W448 LQ
 Top Cambria Berwyn
 Top Thickness 2 CM
 Dimensions SEE ARCHITECTURAL DRAWINGS
 Hardware TBD

SPECIAL INSTRUCTIONS:

1. Please Refer to TBE Standard Construction Standards
2. All Lumber/Joinery/Hardware/Finishing to Comply with AWI Standards for Vanities in Damp Locations

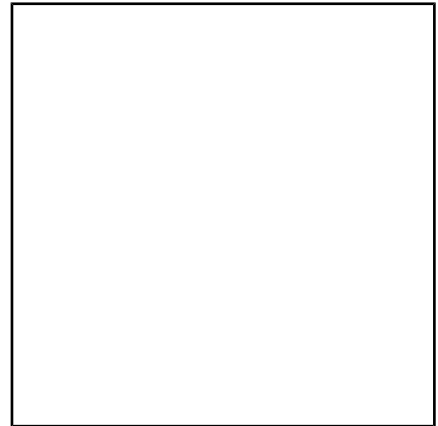

TBD

AREAS



Project: 609

Issue Date: 03 FEB 2017
Revision Date:

Mfr: HF Collection
465 Forbes Blvd
South San Francisco , CA 94080, United States
P: 650-952-2546 F: 650-952-2681
www.hf-collection.com

Rep: Sarah Turner
United States
P: 650-952-2546 F: 650-952-2681
sarah@hf-collection.com

Contact:

Contact:

Total Qty: 0 Each Area Qty: 0 Each Bulk Qty: 0 Each Lead Time: (weeks) 16-18

- Finish Sample
- Strike-Off
- Cutting
- Shop Dwgs
- Prototype
- Seaming Diag
- CAD Drawing
- Cut Sheet
- Flame Certification

Item Name ADA 2 Room Suite Drybar
 Description Drybar with Refrigerator Cabinet
 Model # TBD
 Cabinet & Panel Finish Stain To Match Arborite W448 LQ
 Top Cambria Berwyn
 Top Thickness 2 CM
 Dimensions SEE ARCHITECTURAL DRAWINGS
 Hardware TBD

SPECIAL INSTRUCTIONS:

1. Please Refer to TBE Standard Construction Standards
2. All Lumber/Joinery/Hardware/Finishing to Comply with AWI Standards for Vanities in Damp Locations

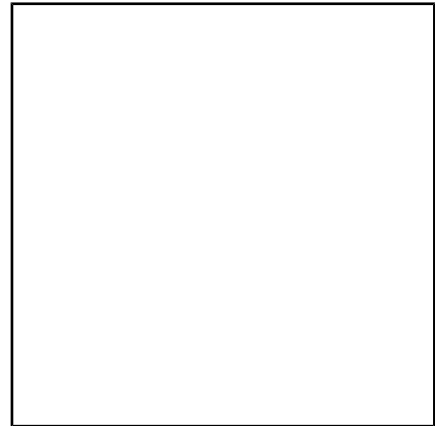

TBD

AREAS



CG-37.H

Revision 1

Casegoods

Project: 609

Issue Date: 03 FEB 2017
Revision Date: 20 DEC 2016 (1)

Mfr: HF Collection
465 Forbes Blvd
South San Francisco, CA 94080, United States
P: 650-952-2546 F: 650-952-2681
www.hf-collection.com

Rep: Sarah Turner
United States
P: 650-952-2546 F: 650-952-2681
sarah@hf-collection.com

Contact:

Contact:

Total Qty: 0 Each Area Qty: 0 Each Bulk Qty: 0 Each Lead Time: (weeks) 16-18

- Finish Sample
- Strike-Off
- Cutting
- Shop Dwgs
- Prototype
- Seaming Diag
- CAD Drawing
- Cut Sheet
- Flame Certification

Item Name	Extended King Dresser/Drybar Combo
Description	Custom Six Drawer Dresser/Drybar Combo
Finish	Stained To Match Arborite W-448 LQ
Dimensions	8'-8"W X 2'-1/2"D X 34"OAH
Hardware	Similar to image provided
Drawer Safe	SAFEMARK SYSTEMS DNX 5.4
Solid Surface Top	Cambria Edinborough Top
Solid Surface Edge Profile	Eased Edge
Solid Surface Thickness	2CM



Style

SPECIAL INSTRUCTIONS:

- Please Refer to TBE Standard Construction Standards

AREAS



CG-38.H

Revision 1

Casegoods

Project: 609

Issue Date: 03 FEB 2017
Revision Date: 20 DEC 2016 (1)

Mfr: HF Collection
465 Forbes Blvd
South San Francisco, CA 94080, United States
P: 650-952-2546 F: 650-952-2681
www.hf-collection.com

Rep: Sarah Turner
United States
P: 650-952-2546 F: 650-952-2681
sarah@hf-collection.com

Contact:

Contact:

Total Qty: 0 Each Area Qty: 0 Each Bulk Qty: 0 Each Lead Time: (weeks) 16-18

- Finish Sample
- Strike-Off
- Cutting
- Shop Dwgs
- Prototype
- Seaming Diag
- CAD Drawing
- Cut Sheet
- Flame Certification

Item Name: 2 Room Suite TV Console
 Description: Console Below TV in @ Room Suite
 Finish: Stained To Match Arborite W-448 LQ
 Dimensions: 6'-0"W X 0'-8"D X 2'-4"OAH
 Solid Surface Top: Cambria Edinborough Top
 Solid Surface Edge Profile: Eased Edge
 Solid Surface Thickness: 2CM

SPECIAL INSTRUCTIONS:

1. Please Refer to TBE Standard Construction Standards

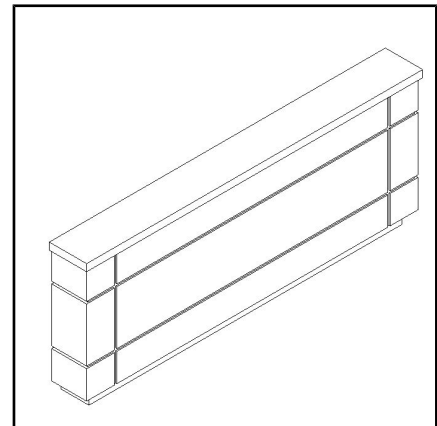

Style

AREAS



CG-39.H

Revision 1

Casegoods

Project: 609

Issue Date: 03 FEB 2017
Revision Date: 29 NOV 2016 (1)

Mfr: HF Collection
465 Forbes Blvd
South San Francisco , CA 94080, United States
P: 650-952-2546 F: 650-952-2681
www.hf-collection.com

Rep: Sarah Turner
United States
P: 650-952-2546 F: 650-952-2681
sarah@hf-collection.com

Contact:

Contact:

Total Qty: 0 Each Area Qty: 0 Each Bulk Qty: 0 Each Lead Time: (weeks) 10-12

- Finish Sample
- Strike-Off
- Cutting
- Shop Dwgs
- Prototype
- Seaming Diag
- CAD Drawing
- Cut Sheet
- Flame Certification

Item Name	Desk - 48"W Extended King
Description	Custom Cantilevered Desk
Finish	Stained To Match Aborite W-448 LQ
Dimensions	4'-0"W X 2'-1/2"D X 2-6"OAH
Hardware	Similar to image provided
Solid Surface Top	Cambria Edinborough Top
Solid Surface Edge Profile	Eased Edge
Solid Surface Thickness	2CM

SPECIAL INSTRUCTIONS:

1. Please Refer to TBE Standard Construction Standards



AREAS

Upholstery



Item Report By Item Type

Project:

Project #: 609

Issue Date: 03 FEB 2017

ItemType: Upholstery

Control #	Item Name	Total Qty	Unit	Item Cost	Total Cost	Revision Date
F-1.H	King Headboard Fabric	0.00	Lin Yds			
F-2.H	Queen Headboard Fabric	0.00	Lin Yds			
F-3.H	Fabric for Lounge Chair Fronts	278.25	Lin Yds			
F-6.H	Fabric for Guestroom Lounge Chair Backs	765.00	Lin Yds			01 NOV 2016 (1)
F-7.H	Fabric for Back of Dining Chair	227.00				
F-9.H	Fabric For Desk Chair	4.00	Lin Yds			
F-11.H	Fabric for Suites Lounge Chair, Dining Chair Seat, Ottomans, & Luggage Benches	405.00	Lin Yds			01 NOV 2016 (1)
F-12.H	Fabric For Sofa Sleeper	544.50	Lin Yds			
F-13.H	Fabric For Pillow Sofas Sleepers	2.00	Lin Yds			
F-15.H	Fabric For Sofa Sleeper Ottomans	0.00	Lin Yds			
F-21.H	Overdrape Face Fabric	0.00	Lin Yds			
F-22.H	Overdrape Liner Fabric	0.00	Lin Yds			
F-23.H	Sheer Fabric	0.00	Lin Yds			
F-24.H	Fabric for Scarf Trim & Backing	0.00				

F-1.H

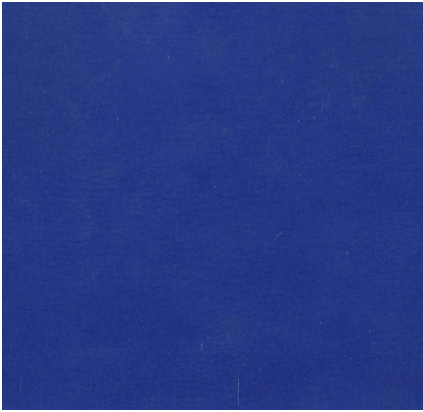

F-2.H

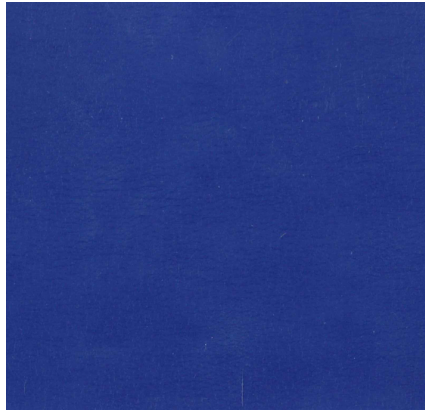

F-3.H

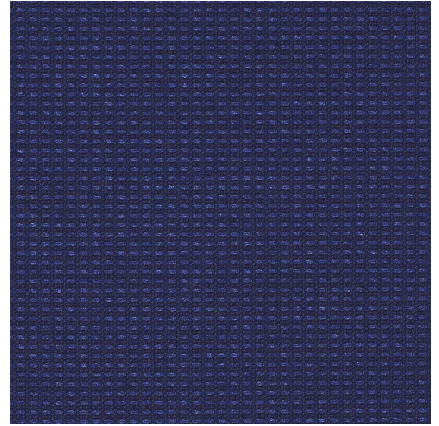

F-6.H



F-7.H



F-9.H

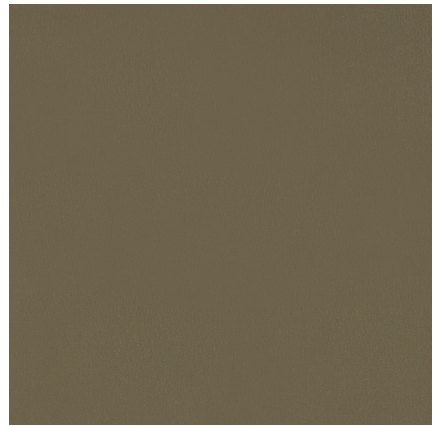

F-11.H

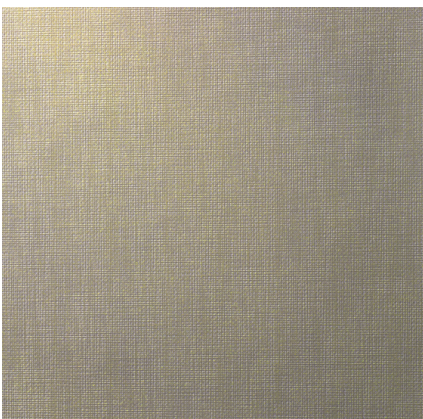

F-12.H



F-13.H





Image Report By Item Type

Project:

Project #: 609

Issue Date: 03 FEB 2017

Item Type: Upholstery

F-15.H

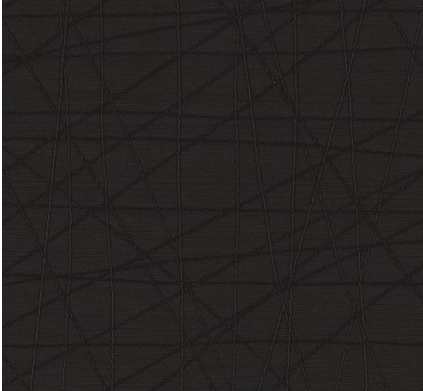

F-21.H

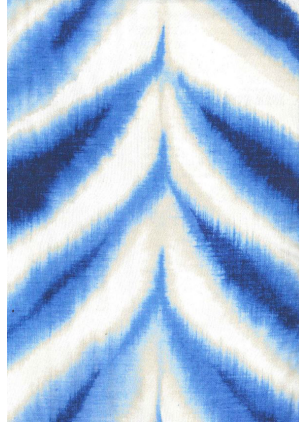

F-22.H

F-23.H



F-24.H





F-1.H

0

Upholstery

Project: 609

Issue Date: 03 FEB 2017
Revision Date:

Mfr: Momentum
17811 Fitch
Irvine, CA 92614, United States
P: 800.366.6839 F: 949.833.9233
www.themomgroup.com

Rep: Michele Land
United States
mland@momtex.com

Contact: Michele Land
P: 800.366.6839 x845
mland@momtex.com

Contact: Default

BUDGET		REQUIRED FOR APPROVAL	
Lead Time: (weeks)	8-10	<input type="checkbox"/> Cutting	<input checked="" type="checkbox"/>
Bulk Qty:	0 Lin Yds	<input type="checkbox"/> Strike Off	<input checked="" type="checkbox"/>
Area Qty:	0 Lin Yds	<input type="checkbox"/> Cut Sheet	<input checked="" type="checkbox"/>
Total Qty:	0 Lin Yds	<input type="checkbox"/> Flame Certification	<input checked="" type="checkbox"/>
			<input checked="" type="checkbox"/>
			<input type="checkbox"/>

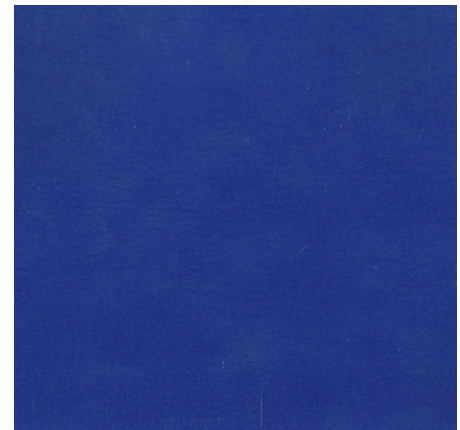

Item Name King Headboard Fabric
 Pattern Custom Silica
 Model # ML5442-A2
 Color Custom
 Content 100% Silicone
 Backing Polyester
 Repeat N/A
 Width 54"
 Shown Railroaded No
 Finish N/A
 Cleaning Code WS; Bleach Cleanable (4:1)
 Abrasion 365,000 Double Rubs
 Flammability CA Bulletin 117 Sec. E

SPECIAL INSTRUCTIONS:

Project:
Project #: 609

Issue Date: 03 FEB 2017
Revision Date:

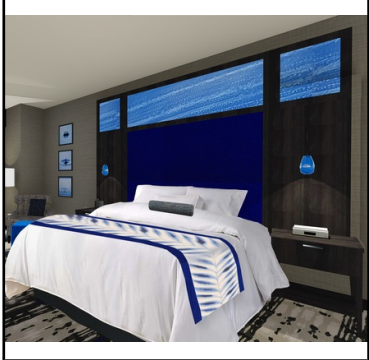

Refer to Spec Sheet CG-1.H | King Headboard

Qty Each: 0 Lin Yds

Total Qty: 0 Lin Yds

INSTRUCTIONS:



F-2.H

0

Upholstery

Project: 609







Issue Date: 03 FEB 2017
Revision Date:

Mfr: Momentum
17811 Fitch
Irvine, CA 92614, United States
P: 800.366.6839 F: 949.833.9233
www.themomgroup.com

Rep: Michele Land
United States
mland@momtex.com

Contact: Michele Land
P: 800.366.6839 x845
mland@momtex.com

Contact: Default

BUDGET		REQUIRED FOR APPROVAL		
Lead Time: (weeks)	8-10	<input type="checkbox"/> Cutting	<input checked="" type="checkbox"/> 	
Bulk Qty:	0 Lin Yds	<input type="checkbox"/> Strike Off	<input checked="" type="checkbox"/> 	
Area Qty:	0 Lin Yds	<input type="checkbox"/> Cut Sheet	<input checked="" type="checkbox"/> 	
Total Qty:	0 Lin Yds	<input type="checkbox"/> Flame Certification	<input checked="" type="checkbox"/> 	
			<input checked="" type="checkbox"/> 	
			<input type="checkbox"/> 	

Item Name: Queen Headboard Fabric
 Pattern: Custom Silica
 Model #: ML5442-A2
 Color: Custom
 Content: 100% Silicone
 Backing: Polyester
 Repeat: N/A
 Width: 54"
 Shown Railroaded: No
 Finish: N/A
 Cleaning Code: WS; Bleach Cleanable (4:1)
 Abrasion: 365,000 Double Rubs
 Flammability: CA Bulletin 117 Sec. E

SPECIAL INSTRUCTIONS:

1. Designer to approve strike off sample before order is placed.

Project:
Project #: 609

Issue Date: 03 FEB 2017
Revision Date:

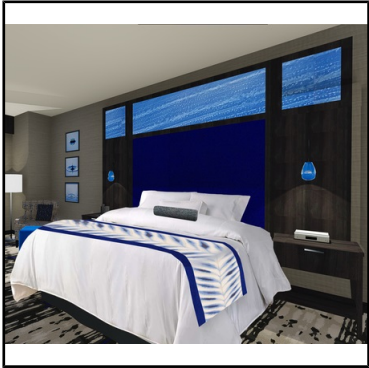

Refer to Spec Sheet CG-2.H | Queen Headboard

Qty Each: 0 Lin Yds

Total Qty: 0 Lin Yds

INSTRUCTIONS:



F-3.H

0

Upholstery

Project: 609

Issue Date: 03 FEB 2017
Revision Date:

Mfr: Momentum
17811 Fitch
Irvine, CA 92614, United States
P: 800.366.6839 F: 949.833.9233
www.themomgroup.com

Rep: Michele Land
United States
mland@momtex.com

Contact: Michele Land
P: 800.366.6839 x845
mland@momtex.com

Contact: Default

BUDGET		REQUIRED FOR APPROVAL	
Lead Time: (weeks)	8-10	<input type="checkbox"/> Cutting	<input checked="" type="checkbox"/>
Bulk Qty:	8 Lin Yds	<input type="checkbox"/> Strike Off	<input checked="" type="checkbox"/>
Area Qty:	270 Lin Yds	<input type="checkbox"/> Cut Sheet	<input checked="" type="checkbox"/>
Total Qty:	278 Lin Yds	<input type="checkbox"/> Flame Certification	<input checked="" type="checkbox"/>
			<input checked="" type="checkbox"/>
			<input type="checkbox"/>

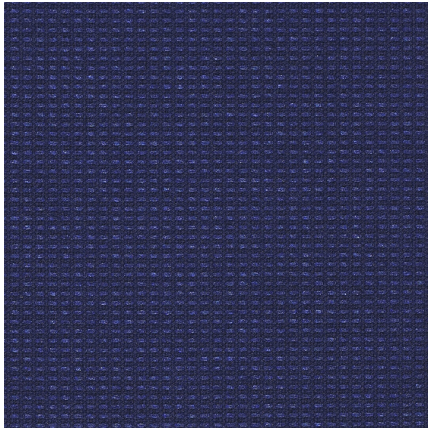

Item Name	Fabric for Lounge Chair Fronts
Pattern	Millenium
Product Number	09143011
Color	Sapphire
Content	85% Post consumer Recycled Polyester, 15% Polyester
Repeat	1/8"L, 1/8"W
Shown Railroaded	No
Finish	Soil & Stain Resistant
Cleaning Code	WS
Durability	200,000 D.R.
Flammability	CA Bulletin 117 2013
Dye	Piece
Backing	Acrylic
Weight	0.82 lb.
Fabric Grade	

SPECIAL INSTRUCTIONS:

Project:
Project #: 609

Issue Date: 03 FEB 2017
Revision Date:



Refer to Spec Sheet CH-1.H | Typical King Guestroom Lounge Chair

Qty Each: 5 Lin Yds Total Qty: 0 Lin Yds

INSTRUCTIONS:

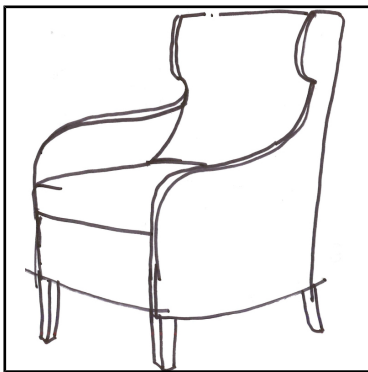

Refer to Spec Sheet CH-5.H | Lounge Chair - Double Queen Rooms

Qty Each: 3 Lin Yds Total Qty: 270 Lin Yds

INSTRUCTIONS:



F-6.H

Revision 1

Upholstery

Project: 609







Issue Date: 03 FEB 2017
Revision Date: 01 NOV 2016 (1)

Mfr: Robert Allen Group
2 Hampshire Street, Suite 300
Foxboro, MA 02035, United States
P: 800-333-3777 F: 800-332-8256

Rep: Kim Caldwell
KDR Designer Showrooms
11660 Page Service Drive
Saint Louis, MO 63146, United States
P: 314-792-0706 F: 314-993-6551
kimc@kdrshowrooms.com

Contact: Default

Contact: Default

BUDGET		REQUIRED FOR APPROVAL		
Lead Time: (weeks)	8-10	<input type="checkbox"/> Cutting	<input type="checkbox"/> 	
Bulk Qty:	495 Lin Yds	<input type="checkbox"/> Strike Off	<input type="checkbox"/> 	
Area Qty:	270 Lin Yds	<input type="checkbox"/> Cut Sheet	<input type="checkbox"/> 	
Total Qty:	765 Lin Yds	<input type="checkbox"/> Flame Certification	<input type="checkbox"/> 	
			<input type="checkbox"/> 	
			<input type="checkbox"/> 	

Item Name	Fabric for Guestroom Lounge Chair Backs
Pattern	Abstract Plaid
Model #	230087
Color	Cobalt
Content	42% Post Consumer Polyester, 37% Polyester, 21% Nylon
Repeat	Vertical: 4", Horizontal: 9"
Width	55"
Railroaded	N/A
Finish	Teflon
Cleaning Code	Pure Solvents Dry Cleaning
Abrasion	50,000 Double Rubs
Flammability	CAL 117, NFPA 260, UFAC I
Fabric Grade	06

SPECIAL INSTRUCTIONS:

Project:
Project #: 609

Issue Date: 03 FEB 2017
Revision Date: 01 NOV 2016 (1)



Refer to Spec Sheet CH-1.H | Typical King Guestroom Lounge Chair

Qty Each: 5 Lin Yds Total Qty: 0 Lin Yds

INSTRUCTIONS:

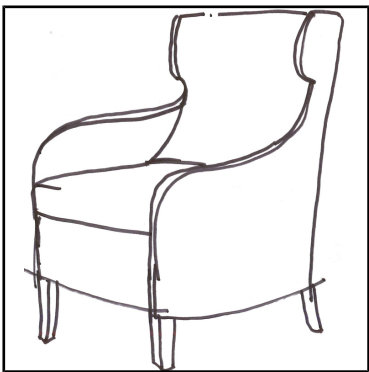

Refer to Spec Sheet CH-5.H | Lounge Chair - Double Queen Rooms

Qty Each: 3 Lin Yds Total Qty: 270 Lin Yds

INSTRUCTIONS:



F-7.H

0

Upholstery

Project: 609

Issue Date: 03 FEB 2017
Revision Date:

Mfr: Robert Allen Group
2 Hampshire Street, Suite 300
Foxboro, MA 02035, United States
P: 800-333-3777 F: 800-332-8256

Rep: Kim Caldwell
KDR Designer Showrooms
11660 Page Service Drive
Saint Louis, MO 63146, United States
P: 314-792-0706 F: 314-993-6551
kimc@kdrshowrooms.com

Contact: Default

Contact: Default

BUDGET		REQUIRED FOR APPROVAL		
Lead Time: (weeks)		<input type="checkbox"/> Cutting	<input checked="" type="checkbox"/>	
Bulk Qty:	2	<input type="checkbox"/> Strike Off	<input checked="" type="checkbox"/>	
Area Qty:	225	<input type="checkbox"/> Cut Sheet	<input checked="" type="checkbox"/>	
Total Qty:	227	<input type="checkbox"/> Flame Certification	<input checked="" type="checkbox"/>	
			<input checked="" type="checkbox"/>	
			<input type="checkbox"/>	



Item Name	Fabric for Back of Dining Chair
Pattern	Abstract Plaid
SKU	230087
Color	Cobalt
Content	42% Post Consumer Polyester, 37% Polyester, 21% Nylon
Repeat	Horizontal 9, Vertical 4
Width	55"
Flammability	CA 117 2013
Repeat Direction	Up the Roll
Fabric Grade	06

SPECIAL INSTRUCTIONS:

Project:
Project #: 609

Issue Date: 03 FEB 2017
Revision Date:



Refer to Spec Sheet CH-6.H | Dining Chair

Qty Each:	1.5	Total Qty:	225
-----------	-----	------------	-----

INSTRUCTIONS:



F-9.H

0

Upholstery

Project: 609

Issue Date: 03 FEB 2017
Revision Date:

Mfr: Momentum
17811 Fitch
Irvine, CA 92614, United States
P: 800.366.6839 F: 949.833.9233
www.themomgroup.com

Rep: Michele Land
United States
mland@momtex.com

Contact: Michele Land
P: 800.366.6839 x845
mland@momtex.com

Contact: Default

BUDGET		REQUIRED FOR APPROVAL	
Lead Time: (weeks)	8-10	<input type="checkbox"/> Cutting	<input checked="" type="checkbox"/>
Bulk Qty:	4 Lin Yds	<input type="checkbox"/> Strike Off	<input checked="" type="checkbox"/>
Area Qty:	0 Lin Yds	<input type="checkbox"/> Cut Sheet	<input checked="" type="checkbox"/>
Total Qty:	4 Lin Yds	<input type="checkbox"/> Flame Certification	<input checked="" type="checkbox"/>
			<input checked="" type="checkbox"/>
			<input type="checkbox"/>

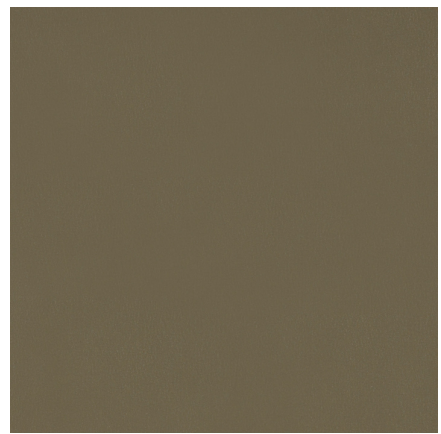

Item Name	Fabric For Desk Chair
Pattern	Silica
Model #	09126621
Color	Sketch
Content	100% Silicone
Backing	Polyester
Repeat	NA
Width	54"
Railroaded	No
Weight	1.60 lb
Finish	-
Maintenance	WS- Water-Based Cleaning Agents or Foam; Bleach Cleanable
Abrasion	365,000 D.R.
Flammability	CA Bulletin 117 2013; UFAC Class 1; NFPA 260 Class 1

SPECIAL INSTRUCTIONS:

Project:
Project #: 609

Issue Date: 03 FEB 2017
Revision Date:



Refer to Spec Sheet CH-7.H | Desk Chair

Qty Each: 1.25 Lin Yds

Total Qty: 0 Lin Yds

INSTRUCTIONS:



F-11.H

Revision 1

Upholstery

Project:
Project #: 609

Issue Date: 03 FEB 2017
Revision Date: 01 NOV 2016 (1)

Mfr: D.L. Couch
499 E. County Road
300 South
New Castle, IN 47362, United States
P: 800.433.0790 F: 800.882.6824
www.dlcouch.com

Rep: Melissa Biethman
499 E. County RD 300 S.
P.O. Box 570
New Castle, IN 47362, United States
P: 314-809-7730 F: 800-882-6824

Contact: Melissa Biethman
P: 800.433.0790 C: 314.809.7730
mbiethman@dlcouch.com

Contact:

BUDGET		REQUIRED FOR APPROVAL	
Lead Time: (weeks)	8-10	<input type="checkbox"/> Cutting	<input checked="" type="checkbox"/>
Bulk Qty:	0 Lin Yds	<input type="checkbox"/> Strike Off	<input checked="" type="checkbox"/>
Area Qty:	405 Lin Yds	<input type="checkbox"/> Cut Sheet	<input checked="" type="checkbox"/>
Total Qty:	405 Lin Yds	<input type="checkbox"/> Flame Certification	<input checked="" type="checkbox"/>
			<input checked="" type="checkbox"/>
			<input type="checkbox"/>

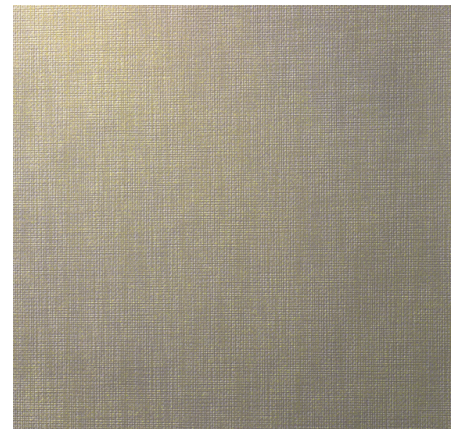

Item Name	Fabric for Suites Lounge Chair, Dining Chair Seat, Ottomans, & Luggage Benches
Pattern	Dante
Model #	UHP-DT-03
Color	Sateen
Content	45% Polyurethane (face), 55% Polyester (back)
Repeat	N/A
Width	54"
Finish	Graffiti-Free
Cleaning Code	W (water-based cleaners)
Abrasion	100,000 Double Rubs
Flammability	Passes CAL TB 117-2013 and UFAC/NFPA 260
Lightfastness	
Seam Slippage	ASTM D1683 Seam Strength: meets requirements
Breaking Strength	ASTM D2261: meets requirements
Hydrolysis Resistance	10 Weeks
Sustainability	Oeko-Tex Standard 100



F-11.H

Revision 1

Upholstery

SPECIAL INSTRUCTIONS:

Project:
 Project #: 609

Issue Date: 03 FEB 2017
 Revision Date: 01 NOV 2016 (1)

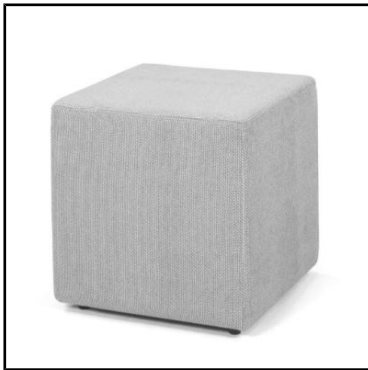
	Refer to Spec Sheet CH-3.H Ottoman at Lounge Chair	
	Qty Each: 2 Lin Yds	Total Qty: 0 Lin Yds
INSTRUCTIONS:		

	Refer to Spec Sheet CH-6.H Dining Chair	
	Qty Each: 1.5 Lin Yds	Total Qty: 225 Lin Yds
INSTRUCTIONS:		

	Refer to Spec Sheet CH-8.H Luggage Bench - with Back	
	Qty Each: 3 Lin Yds	Total Qty: 180 Lin Yds
INSTRUCTIONS:		

	Refer to Spec Sheet CH-9.H Luggage Bench - without back	
	Qty Each: 3 Lin Yds	Total Qty: 0 Lin Yds
INSTRUCTIONS:		



F-11.H

Revision 1

Upholstery



Refer to Spec Sheet CH-10.H | Suites Lounge Chair

Qty Each: 6 Lin Yds

Total Qty: 0 Lin Yds

INSTRUCTIONS:



F-12.H

0

Upholstery

Project:
Project #: 609

Issue Date: 03 FEB 2017
Revision Date:

Mfr: Designtex
P: 800.221.1540
www.designtex.com

Rep: Glenda Jehle
4731 McPherson
Saint Louis, MO 63108, United States
P: 314-863-2228 F: 303-722-7703

Contact: Glenda Jehle
P: 314.863.2228 C: 314.922.6590
gjihle@dtex.com

Contact: Default

BUDGET

REQUIRED FOR APPROVAL

Lead Time: (weeks)	8-10
Bulk Qty:	0 Lin Yds
Area Qty:	544 Lin Yds
Total Qty:	544 Lin Yds

- | | | | |
|-------------------------------------|---------------------|-------------------------------------|--|
| <input type="checkbox"/> | Cutting | <input checked="" type="checkbox"/> | |
| <input type="checkbox"/> | Strike Off | <input checked="" type="checkbox"/> | |
| <input type="checkbox"/> | Cut Sheet | <input checked="" type="checkbox"/> | |
| <input type="checkbox"/> | Flame Certification | <input checked="" type="checkbox"/> | |
| <input checked="" type="checkbox"/> | | <input checked="" type="checkbox"/> | |
| <input type="checkbox"/> | | <input checked="" type="checkbox"/> | |



Item Name	Fabric For Sofa Sleeper
Pattern	Hashtag
Model #	3662-803
Color	Chalkboard
Content	47% Acrylic, 53% Polyester
Backing	Acrylic
Width	54"
Shown Railroaded	No
Weight	18 oz/ly
Finish	Stain Repellent
Cleaning Code	Water-based/Solvent (WS)
Abrasion	80,000 Double Rubs
Flammability	CA TB 117-2013 , NFPA 260
Lightfastness	40 hours

SPECIAL INSTRUCTIONS:

Project:
Project #: 609

Issue Date: 03 FEB 2017
Revision Date:



Refer to Spec Sheet CH-11.H | Queen Sofa Sleeper

Qty Each: 16.5 Lin Yds

Total Qty: 544.5 Lin Yds

INSTRUCTIONS:



F-13.H

0

Upholstery

Project:
Project #: 609







Issue Date: 03 FEB 2017
Revision Date:

Mfr: Paul Brayton Designs
403 Interstate Drive
Archdale, NC 27263, United States
P: 336.882-5200
www.paulbraytondesigns.com

Rep: Liz Buhr and Company
United States
P: 314-412-2120 F: 847-657-7641
lbuhr@sbcglobal.net

Contact: Default

Contact: Default

BUDGET		REQUIRED FOR APPROVAL		
Lead Time: (weeks)	8-10	<input checked="" type="checkbox"/> Cutting	<input checked="" type="checkbox"/> 	
Bulk Qty:	0 Lin Yds	<input type="checkbox"/> Strike Off	<input checked="" type="checkbox"/> 	
Area Qty:	2 Lin Yds	<input checked="" type="checkbox"/> Cut Sheet	<input checked="" type="checkbox"/> 	
Total Qty:	2 Lin Yds	<input checked="" type="checkbox"/> Flame Certification	<input checked="" type="checkbox"/> 	
			<input checked="" type="checkbox"/> 	
			<input type="checkbox"/> 	

Item Name	Fabric For Pillow Sofas Sleepers
Pattern	Prizm
Model #	PR-45
Color	Pipeline
Content	65% Rayon, 35% Recycled Solution Dyed Nylon
Backing	Light Acrylic
Repeat	14.2"H X 12"V
Width	54"
Railroad	No
Finish	Incase
Cleaning Code	S
Abrasion	50,000+ DR
Flammability	California Technical Bulletin 117: 2013

SPECIAL INSTRUCTIONS:

Project:
Project #: 609

Issue Date: 03 FEB 2017
Revision Date:

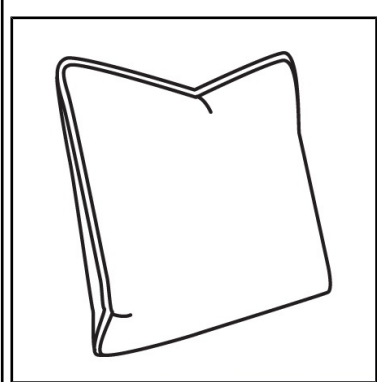

Refer to Spec Sheet CH-14.H | Pillow For Sofa Sleepers

Qty Each: 1 Lin Yds

Total Qty: 2 Lin Yds

INSTRUCTIONS:



F-15.H

0

Upholstery

Project:
Project #: 609

Issue Date: 03 FEB 2017
Revision Date:

Mfr: Designtex
P: 800.221.1540
www.designtex.com

Rep: Glenda Jehle
4731 McPherson
Saint Louis, MO 63108, United States
P: 314-863-2228 F: 303-722-7703

Contact: Glenda Jehle
P: 314.863.2228 C: 314.922.6590
gjehle@dtex.com

Contact: Default

BUDGET

REQUIRED FOR APPROVAL

Lead Time: (weeks)	8-10
Bulk Qty:	0 Lin Yds
Area Qty:	0 Lin Yds
Total Qty:	0 Lin Yds

- | | | | |
|--------------------------|---------------------|-------------------------------------|--|
| <input type="checkbox"/> | Cutting | <input checked="" type="checkbox"/> | |
| <input type="checkbox"/> | Strike Off | <input checked="" type="checkbox"/> | |
| <input type="checkbox"/> | Cut Sheet | <input checked="" type="checkbox"/> | |
| <input type="checkbox"/> | Flame Certification | <input checked="" type="checkbox"/> | |
| | | <input checked="" type="checkbox"/> | |
| | | <input type="checkbox"/> | |

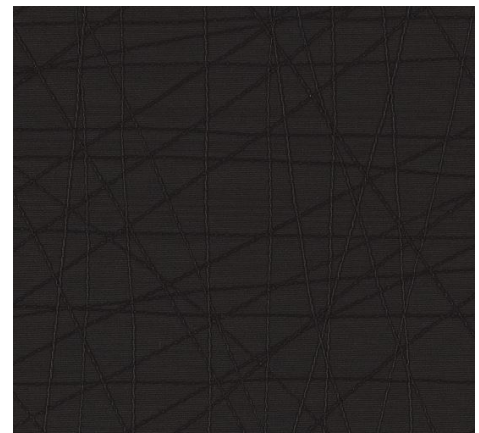

Item Name	Fabric For Sofa Sleeper Ottomans
Pattern	Rove
Model #	3630-804
Color	Midnight
Content	100% Vinyl
Backing	Cotton, Woven
Repeat	Vertical: 14.3" x Horizontal: 18"
Width	59"
Shown Railroaded	No
Weight	41.3 oz/ly
Cleaning Code	W, Bleach Cleanable (10:1)
Abrasion	100,000 Wyzenbeek
Flammability	CA TB 117-2013 , NFPA 260
Lightfastness	40 hours

SPECIAL INSTRUCTIONS:

Project:
Project #: 609

Issue Date: 03 FEB 2017
Revision Date:



Refer to Spec Sheet CH-15.H | Ottoman at Sofa Sleepers

Qty Each: 2 Lin Yds

Total Qty: 0 Lin Yds

INSTRUCTIONS:



F-21.H

0

Upholstery

Project:
Project #: 609

Issue Date: 03 FEB 2017
Revision Date:

Mfr: Fabricut
9303 East 46th Street
Tulsa, OK 74145, United States
P: 800.999.5533
www.fabricutcontract.com

Rep: Karma Lamping
United States
kl1491@msn.com

Contact: Karma Lamping
P: 800.999.8200 C: 314.315.6732
kl1491@msn.com

Contact: Default

BUDGET		REQUIRED FOR APPROVAL	
Lead Time: (weeks)	8-10	<input type="checkbox"/> Cutting	<input type="checkbox"/>
Bulk Qty:	0 Lin Yds	<input type="checkbox"/> Strike Off	<input type="checkbox"/>
Area Qty:	0 Lin Yds	<input type="checkbox"/> Cut Sheet	<input type="checkbox"/>
Total Qty:	0 Lin Yds	<input type="checkbox"/> Flame Certification	<input type="checkbox"/>
			<input type="checkbox"/>
			<input type="checkbox"/>

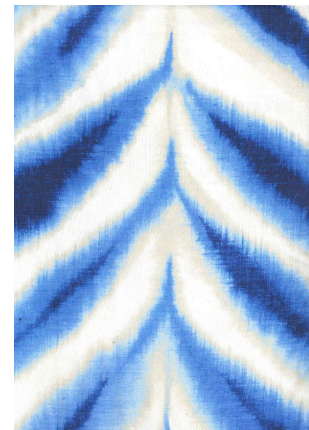

Item Name	Overdrape Face Fabric
Pattern	Santiago FR
Color	Indigo
Content	100% FR- Polyester
Repeat	13.4"Vert.; 13.5"Horz.
Width	54"
Railroad	No
Cleaning Code	Washable
Flammability	Passes NFPA 701

SPECIAL INSTRUCTIONS:

Project:
Project #: 609

Issue Date: 03 FEB 2017
Revision Date:

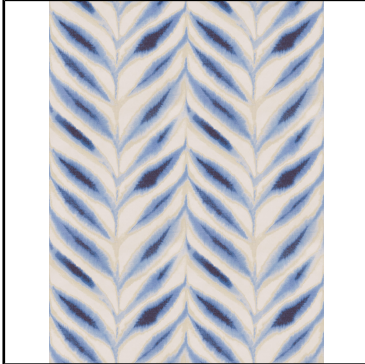

Refer to Spec Sheet B-4.H | Guestroom Throw for Bed

Qty Each: 0 Lin Yds

Total Qty: 0 Lin Yds

INSTRUCTIONS:



F-22.H

0

Upholstery

Project:
Project #: 609

Issue Date: 03 FEB 2017
Revision Date:

Mfr:

Rep:

Contact:

Contact:

BUDGET		REQUIRED FOR APPROVAL	
Lead Time: (weeks)	8-10	<input type="checkbox"/> Cutting	<input type="checkbox"/>
Bulk Qty:	0 Lin Yds	<input type="checkbox"/> Strike Off	<input type="checkbox"/>
Area Qty:	0 Lin Yds	<input type="checkbox"/> Cut Sheet	<input type="checkbox"/>
Total Qty:	0 Lin Yds	<input type="checkbox"/> Flame Certification	<input type="checkbox"/>
			<input type="checkbox"/>
			<input type="checkbox"/>

Item Name Overdrape Liner Fabric

SPECIAL INSTRUCTIONS:



F-23.H

0

Upholstery

Project: 609







Issue Date: 03 FEB 2017
Revision Date:

Mfr: Fabricut
9303 East 46th Street
Tulsa, OK 74145, United States
P: 800.999.5533
www.fabricutcontract.com

Rep: Karma Lamping
United States
kl1491@msn.com

Contact: Karma Lamping
P: 800.999.8200 C: 314.315.6732
kl1491@msn.com

Contact: Default

BUDGET		REQUIRED FOR APPROVAL		
Lead Time: (weeks)	8-10	<input type="checkbox"/> Cutting	<input type="checkbox"/> 	
Bulk Qty:	0 Lin Yds	<input type="checkbox"/> Strike Off	<input type="checkbox"/> 	
Area Qty:	0 Lin Yds	<input type="checkbox"/> Cut Sheet	<input type="checkbox"/> 	
Total Qty:	0 Lin Yds	<input type="checkbox"/> Flame Certification	<input type="checkbox"/> 	
			<input type="checkbox"/> 	
			<input type="checkbox"/> 	

Item Name	Sheer Fabric
Pattern	Concerto
Color	Ivory
Content	100% Polyester
Repeat	.7"Vert; .1"Horz.
Width	116"
Double Rubs	None
Railroad	Yes
Finish	None
Cleaning Code	S
Flammability	Passes NFPA 701

SPECIAL INSTRUCTIONS:



F-24.H

0

Upholstery

Project: 609

Issue Date: 03 FEB 2017
Revision Date:

Mfr: Fabricut
9303 East 46th Street
Tulsa, OK 74145, United States
P: 800.999.5533
www.fabricutcontract.com

Rep: Karma Lamping
United States
kl11491@msn.com

Contact: Karma Lamping
P: 800.999.8200 C: 314.315.6732
kl11491@msn.com

Contact: Default

BUDGET		REQUIRED FOR APPROVAL	
Lead Time: (weeks)		<input type="checkbox"/> Cutting	<input type="checkbox"/>
Bulk Qty:	0	<input type="checkbox"/> Strike Off	<input type="checkbox"/>
Area Qty:	0	<input type="checkbox"/> Cut Sheet	<input type="checkbox"/>
Total Qty:	0	<input type="checkbox"/> Flame Certification	<input type="checkbox"/>
			<input type="checkbox"/>
			<input type="checkbox"/>

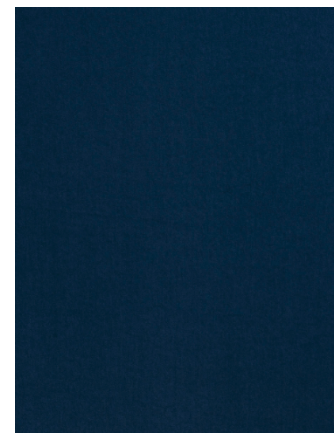

Item Name	Fabric for Scarf Trim & Backing
Pattern	Prestige
Color	L Sapphire
Content	100% Polyester
Backing	None
Repeat	None
Width	54.00 in.
Railroad	Not railroaded
Finish	None
Cleaning Code	S
Double Rubs	100,000 Double Rubs
Fire Codes	Passes "NFPA 701" 2010

SPECIAL INSTRUCTIONS:

Lighting



Item Report By Item Type

Project:

Project #: 609

Issue Date: 03 FEB 2017

ItemType: Lighting

Control #	Item Name	Total Qty	Unit	Item Cost	Total Cost	Revision Date
L-1.H	Desk Lamp	0				
L-2.H	Floor Lamp	0	Each			
L-3.H	Double Queen Table Lamp	0	Each			
L-4.H	Suites End Table Lamp	0				



Image Report By Item Type

Project:

Project #: 609

Issue Date: 03 FEB 2017

Item Type: Lighting

L-1.H



L-2.H



L-3.H



L-4.H





L-1.H

Lighting

Project: 609

Issue Date: 03 FEB 2017
Revision Date:

Mfr: Arkansas Lighting
1701 South 28th
Van Buren, AR 72956, United States
P: 479-474-0876 F: 479-474-9007
www.arkansaslighting.com

Rep: Maria Neri
1701 South 28th
Van Buren, AR 72956, United States
P: 479-474-0876 F: 479-474-9007
mneri@arkansaslighting.com

Contact:

Contact:

Total Qty: 0 Area Qty: 0 Bulk Qty: 0 Lead Time: (weeks)

- Finish Sample
- Strike-Off
- Cutting
- Shop Dwgs
- Prototype
- Seaming Diag
- CAD Drawing
- Cut Sheet
- Flame Certification

Item Name	Desk Lamp
Description	Table Lamp
Model #	6276EO
Lamp Dimensions	30"H
Lamp Finish	Brushed Nickel
Switch	On/Off rocker switch at base
Bulb Wattage	Recommend 27 watt CFL or 11 watt LED bulb
Cordset	8' 3-prong grounded cordset
Socket	Medium Base
Base	6.5"W, 6.5"D
Shade Part Number	1616105LWNI
Shade Material	White Linen
Shade Dimensions	16"x16"x10.5"
Harp	NA
Added Feature	Reference special instructions for additional instructions to be included in lamp



SPECIAL INSTRUCTIONS:

1. UL Listed
2. To be included in lamp: 2 convenience outlets, 2 USB ports

AREAS



L-2.H

Lighting

Project: 609

Issue Date: 03 FEB 2017
Revision Date:

Mfr: Arkansas Lighting
1701 South 28th
Van Buren, AR 72956, United States
P: 479-474-0876 F: 479-474-9007
www.arkansaslighting.com

Rep: Maria Neri
1701 South 28th
Van Buren, AR 72956, United States
P: 479-474-0876 F: 479-474-9007
mneri@arkansaslighting.com

Contact:

Contact:

Total Qty: 0 Each Area Qty: 0 Each Bulk Qty: 0 Each Lead Time: (weeks)

- Finish Sample
- Strike-Off
- Cutting
- Shop Dwgs
- Prototype
- Seaming Diag
- CAD Drawing
- Cut Sheet
- Flame Certification

Item Name	Floor Lamp
Description	Floor Lamp
Model #	6209FPC
Lamp Dimensions	64"H
Lamp Finish	Metallic Silver
Switch	On/Off push through socket switch
Bulb Wattage	Recommend 32 or 27 watt CFL bulb
Cordset	11' usable SPT-2 power supply cord with polarized plug
Socket	Medium Base
Base	11"W, 11"D
Shade Part Number	1414120PR
Shade Material	White Linen
Shade Dimensions	14"x14"x14"x14"x12"
Harp	10"



SPECIAL INSTRUCTIONS:
1. UL Listed

AREAS



L-3.H

Lighting

Project:
Project #: 609

Issue Date: 03 FEB 2017
Revision Date:

Mfr: Arkansas Lighting
1701 South 28th
Van Buren, AR 72956, United States
P: 479-474-0876 F: 479-474-9007
www.arkansaslighting.com

Rep: Maria Neri
1701 South 28th
Van Buren, AR 72956, United States
P: 479-474-0876 F: 479-474-9007
mneri@arkansaslighting.com

Contact:

Contact:

Total Qty: 0 Each Area Qty: 0 Each Bulk Qty: 0 Each Lead Time: (weeks) 14-16

- Finish Sample
- Strike-Off
- Cutting
- Shop Dwgs
- Prototype
- Seaming Diag
- CAD Drawing
- Cut Sheet
- Flame Certification

Item Name Double Queen Table Lamp

Description Table Lamp with 3-way, 4 position push button base switch

Model # 5688E20-S

Frame Finish Espresso/Brushed Nickel

Shade Finish White Linen

Shade Dimensions Shade Top: 8" x 15", Shade Bottom: 8" x 15", Shade Depth: 10"

Volts / Wattage Two 19 Watt CFL or 10 Watt LED Bulbs

Cord Length 8' 45° 3-prong grounded cordset

Cord Color

SPECIAL INSTRUCTIONS:

1. UL Listed



AREAS



L-4.H

Lighting

Project: 609

Issue Date: 03 FEB 2017
Revision Date:

Mfr: Arkansas Lighting
1701 South 28th
Van Buren, AR 72956, United States
P: 479-474-0876 F: 479-474-9007
www.arkansaslighting.com

Rep: Maria Neri
1701 South 28th
Van Buren, AR 72956, United States
P: 479-474-0876 F: 479-474-9007
mneri@arkansaslighting.com

Contact:

Contact:

Total Qty: 0 Area Qty: 0 Bulk Qty: 0 Lead Time: (weeks)

- Finish Sample
- Strike-Off
- Cutting
- Shop Dwgs
- Prototype
- Seaming Diag
- CAD Drawing
- Cut Sheet
- Flame Certification

Item Name Suites End Table Lamp
 Description Table Lamp
 Model # 6277EO-USB
 Lamp Dimensions 31"H
 Lamp Finish Brushed Nickel and Silver Wood
 Switch On/Off rocker base switch
 Bulb Wattage Recommend 27 watt CFL or 11 watt LED bulb
 Cordset 8' 45 degree angle 3-prong grounded cordset
 Socket Medium Base
 Base 9"W, 6"D
 Shade Part Number 0909115RLWNI
 Shade Material White Linen
 Shade Dimensions 9"x16"x9"x19"x11.5"
 Harp 10"
 Miscellaneous With one convenience outlet and one USB port



SPECIAL INSTRUCTIONS:

- 1. UL Listed

AREAS

Fixed Lighting



Item Report By Item Type

Project:

Project #: 609

Issue Date: 03 FEB 2017

ItemType: Fixed Lighting

Control #	Item Name	Total Qty	Unit	Item Cost	Total Cost	Revision Date
FL-1.H	King Nightstand Wall Sconce	0	Each			
FL-2.H	Double Queen Nightstand Wall Sconce	0				
FL-3.H	Reading Lamp at Nightstand	0	Each			
FL-4.H	Wall Sconce At Entry Door	0	Each			
FL-5.H	Ceiling Fixture at Door Drops	0	Each			
FL-6.H	Electric Mirror	0	Each			

FL-1.H

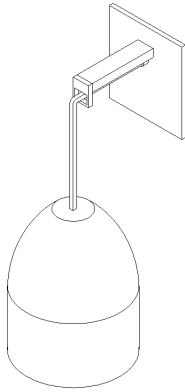

FL-2.H

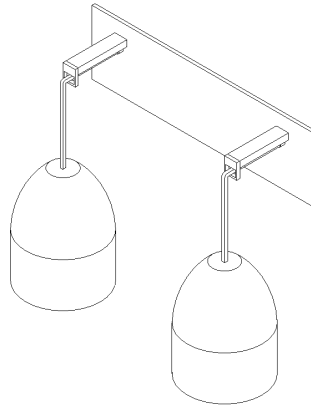

FL-3.H



FL-4.H



FL-5.H



FL-6.H





FL-1.H

Fixed Lighting

Project: 609

Issue Date: 03 FEB 2017
Revision Date:

Mfr: Lighting Associates
3216 South Brentwood Blvd.
Webster Groves, MO 63119, United States
P: 314-531-3500 F: 314-531-3737
www.laiweb.net

Rep: Callia Ball
3216 S Brentwood Blvd
Webster Groves, MO 63119, United States
P: 314-406-9946
www.laiweb.net

Contact:

Contact: cball@laiweb.net

Total Qty: 0 Each Area Qty: 0 Each Bulk Qty: 0 Each Lead Time: (weeks) 8-10

- Finish Sample
- Strike-Off
- Cutting
- Shop Dwgs
- Prototype
- Seaming Diag
- CAD Drawing
- Cut Sheet
- Flame Certification

Item Name King Nightstand Wall Sconce
 Description Ensu Wall Canopy with Chill Pendant in Blue
 Model #
 Canopy Finish Matte Black
 Canopy Dimensions 4.75"W x 5.25"H x 4.5"D
 Voltage/Wattage 120v in/12v LED out
 Lamping LED
 Pendant Name Chill
 Pendant Color Blue
 Pendant Model # HS583
 Pendant Finish Satin Nickel
 Pendant Lamping 1B GY6 .35 Xenon 50w
 Mount FSJ Fusion Jack

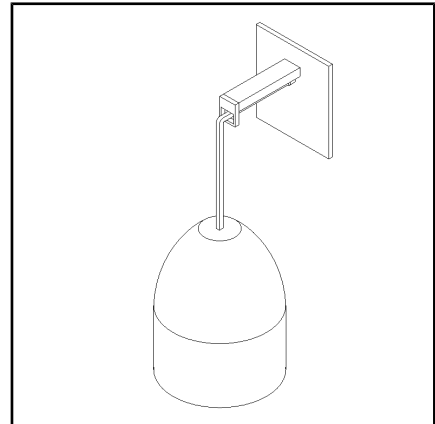

Glass Shade

SPECIAL INSTRUCTIONS:

AREAS



FL-2.H

Fixed Lighting

Project: 609

Issue Date: 03 FEB 2017
Revision Date:

Mfr: Lighting Associates
3216 South Brentwood Blvd.
Webster Groves, MO 63119, United States
P: 314-531-3500 F: 314-531-3737
www.laiweb.net

Rep:

Contact:

Contact:

Total Qty: 0 Area Qty: 0 Bulk Qty: 0 Lead Time: (weeks)

- Finish Sample
- Strike-Off
- Cutting
- Shop Dwgs
- Prototype
- Seaming Diag
- CAD Drawing
- Cut Sheet
- Flame Certification

Item Name: Double Queen Nightstand Wall Sconce
 Description: Ensu Wall Canopy with Chill Pendant in Blue
 Model #:
 Finish: Matte Black
 Dimensions:
 Voltage/Wattage: 120v in/12v LED out
 Lamping: LED
 Pendant Name: Chill
 Pendant Color:
 Pendant Model #: HS583
 Pendant Finish: Satin Nickel
 Pendant Lamping: 1B GY6 .35 Xenon 50w
 Mount: FSJ Fusion Jack

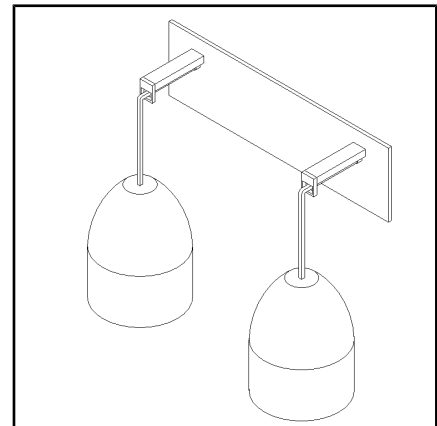

Actual color depicted



Image for reference only, Metal finish not accurate

SPECIAL INSTRUCTIONS:

AREAS



FL-3.H

Fixed Lighting

Project: 609

Issue Date: 03 FEB 2017
Revision Date:

Mfr: Arkansas Lighting
1701 South 28th
Van Buren, AR 72956, United States
P: 479-474-0876 F: 479-474-9007
www.arkansaslighting.com

Rep: Maria Neri
1701 South 28th
Van Buren, AR 72956, United States
P: 479-474-0876 F: 479-474-9007
mneri@arkansaslighting.com

Contact:

Contact:

Total Qty: 0 Each Area Qty: 0 Each Bulk Qty: 0 Each Lead Time: (weeks) 8-10

- Finish Sample
- Strike-Off
- Cutting
- Shop Dwgs
- Prototype
- Seaming Diag
- CAD Drawing
- Cut Sheet
- Flame Certification

Item Name	Reading Lamp at Nightstand
Description	LED Headboard Reading Light
Model #	6394S-LED
Finish	Brushed Nickel
Dimensions	6-3/4"W
Voltage/Wattage	2700K
Lamping	
Power Cord	8 foot
Power Cord Color	Black
Switching	Switches off when arm is closed, turns on when arm is opened



SPECIAL INSTRUCTIONS:

AREAS



FL-4.H

Fixed Lighting

Project: 609

Issue Date: 03 FEB 2017
Revision Date:

Mfr: Arkansas Lighting
1701 South 28th
Van Buren, AR 72956, United States
P: 479-474-0876 F: 479-474-9007
www.arkansaslighting.com

Rep: Maria Neri
1701 South 28th
Van Buren, AR 72956, United States
P: 479-474-0876 F: 479-474-9007
mneri@arkansaslighting.com

Contact:

Contact:

Total Qty: 0 Each Area Qty: 0 Each Bulk Qty: 0 Each Lead Time: (weeks) 14 weeks

- Finish Sample
- Strike-Off
- Cutting
- Shop Dwgs
- Prototype
- Seaming Diag
- CAD Drawing
- Cut Sheet
- Flame Certification

Item Name	Wall Sconce At Entry Door
Description	Wall Sconce
Model #	3910 C
Finish	Matte Black
Overall Height	24"
Voltage/Wattage	GU24 Socket
Lamping	26 watt PL style bulb with GU24 Base
Wired	Direct
Shade Color	White Acrylic Shade
Stem Support & Screw Covers	To be matte gold metal finish

SPECIAL INSTRUCTIONS:



Image for style reference only, Metal finish not accurately represented.

AREAS



FL-5.H

Fixed Lighting

Project:
Project #: 609

Issue Date: 03 FEB 2017
Revision Date:

Mfr: Lumetta Inc.
33 Minnesota Ave.
Warwick, RI 02888, United States
P: 401-691-3994 F: 401-921-1310

Rep: Saint Louis Lighting Group
7414 Manchester Road
St. Louis, Mo. 63143, United States
P: 314-963-3311

Contact:

Contact:

Total Qty: 0 Each Area Qty: 0 Each Bulk Qty: 0 Each Lead Time: (weeks) 10-12

- Finish Sample
- Strike-Off
- Cutting
- Shop Dwgs
- Prototype
- Seaming Diag
- CAD Drawing
- Cut Sheet
- Flame Certification

Item Name	Ceiling Fixture at Door Drops
Description	Custom 34" Diameter Drum Pendant
Model #	P53408-F6-D868-3/18.9W LED-UNV-STM2-DIM
Finish	Powder Coat Brass
Lens Finish	Etched White; Top and Bottom Lens
Dimensions	34"Dia. X 8"Deep
Stem Length	2'
Light Source	Qty.3 18.9W 3,000K Xiacato LEDs; Universal; 0-10V; Dimmable



SPECIAL INSTRUCTIONS:

AREAS



FL-6.H

Fixed Lighting

Project: _____
Project #: 609

Issue Date: 03 FEB 2017
Revision Date:

Mfr: Electric Mirror
6101 Associated Blvd
Suite 101
Everett, WA 98204, United States
P: 425-776-4946 F: 425-491-8200
www.electricmirror.com

Rep:

Contact:

Contact:

Total Qty: 0 Each Area Qty: 0 Each Bulk Qty: 0 Each Lead Time: (weeks) 8-10

- Finish Sample
- Strike-Off
- Cutting
- Shop Dwgs
- Prototype
- Seaming Diag
- CAD Drawing
- Cut Sheet
- Flame Certification

Item Name Electric Mirror
 Description Typical Guestroom Electric Vanity Mirror
 Model # Integrity
 Dimensions 72"W X 42"H X 3"D
 Voltage/Wattage 114
 Lamping LED
 SPECIAL INSTRUCTIONS:

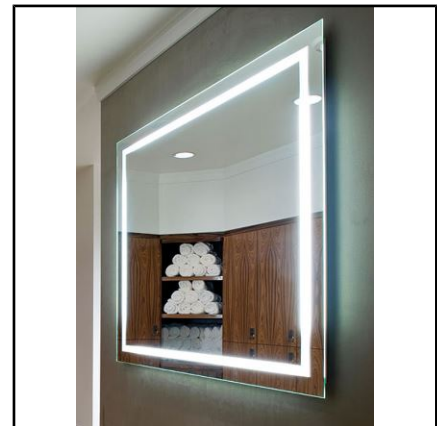

AREAS

Miscellaneous



Item Report By Item Type

Project:

Project #: 609

Issue Date: 03 FEB 2017

ItemType: Miscellaneous

Control #	Item Name	Total Qty	Unit	Item Cost	Total Cost	Revision Date
M-1	Drawer Safe for Dressers	0				



Image Report By Item Type

Project:

Project #: 609

Issue Date: 03 FEB 2017

Item Type: Miscellaneous

M-1





Project:
Project #: 609

Issue Date: 03 FEB 2017
Revision Date:

Mfr: Safemark Systems
2101 Park Center Drive
Suite 125
Orlando, Florida United States
P: 1-800-255-8818
www.safemark.com

Rep:

Contact:

Contact:

Total Qty: 0 Area Qty: 0 Bulk Qty: 0 Lead Time: (weeks)

- Finish Sample, Strike-Off, Cutting, Shop Dwgs, Prototype, Seaming Diag, CAD Drawing, Cut Sheet, Flame Certification

Item Name: Drawer Safe for Dressers
Description: DNX 5.4
Dimensions: 19.75"W x 3.38"H x 13.75"D / Door Opening: 18.25"W, 75 degree maximum opening angle
Color:
Features: 4 Digit User Code, Illuminated ADA-Compliant Keypad, Enhanced LED Display, Audio Visual Operating Signals, 240 Event Audit Trail, Low Battery Indicator, Self-Diagnostic System, Motorized Locking System, Dual Hydraulic Arm Assist, Internal Light



SPECIAL INSTRUCTIONS:

AREAS

Bedding



Item Report By Item Type

Project:

Project #: 609

Issue Date: 03 FEB 2017

ItemType: Bedding

Control #	Item Name	Total Qty	Unit	Item Cost	Total Cost	Revision Date
B-4.H	Guestroom Throw for Bed	0	Each			



Image Report By Item Type

Project:

Project #: 609

Issue Date: 03 FEB 2017

Item Type: Bedding

B-4.H





Project: 609

Issue Date: 03 FEB 2017
Revision Date:

Mfr: Fabricut
9303 East 46th Street
Tulsa, OK 74145, United States
P: 800.999.5533
www.fabricutcontract.com

Rep: Karma Lamping
United States
kll1491@msn.com

Contact: Karma Lamping
P: 800.999.8200 C: 314.315.6732
kll1491@msn.com

Contact:

Total Qty: 0 Each Area Qty: 0 Each Bulk Qty: 0 Each Lead Time: (weeks) 8-10

- Finish Sample
- Strike-Off
- Cutting
- Shop Dwgs
- Prototype
- Seaming Diag
- CAD Drawing
- Cut Sheet
- Flame Certification

Item Name: Guestroom Throw for Bed
 Description: Santiago FR One Indigo
 Content: 100% FR-Polyester
 Application: Fabric
 Width: 54"
 Colors: Blue, Light Blue, Off White
 Vertical Repeat: 13.40"
 Horizontal Repeat: 13.50"
 Scale: Large
 Railroaded: Not railroaded
 Fire Codes: OEKO TEX STANDARD 100
 UFAC CLASS I/NFPA 260A
 PASSES "NFPA 701" 2010
 BOSTON FIRE TEST BFD
 IMO A 471
 Finish/Backing: None
 Collection: FR-One Collection 10-2014
 Double Rubs: Not available
 Cleaning Codes: None
 Trim: Fabricut: Pattern-Prestige/ Color- Sapphire

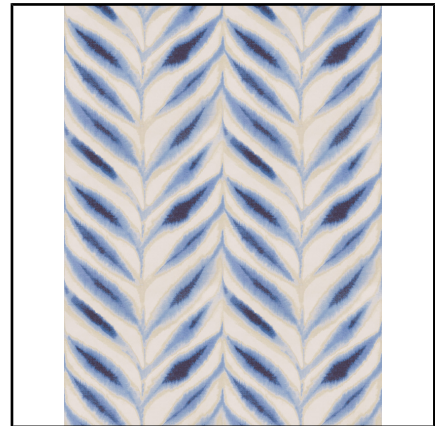

Trim to be applied to throw

AREAS

SPECIAL INSTRUCTIONS:

Project:
Project #: 609

Issue Date: 03 FEB 2017
Revision Date:



Upholstery - | Refer to F-21.H, Overdrape Face Fabric

Mfr:	Fabricut	Qty:	0 Lin Yds
Pattern:	Santiago FR		
Color:	Indigo		

INSTRUCTIONS:



F-21.H

0

Upholstery

Project:
Project #: 609







Issue Date: 03 FEB 2017
Revision Date:

Mfr: Fabricut
9303 East 46th Street
Tulsa, OK 74145, United States
P: 800.999.5533
www.fabricutcontract.com

Rep: Karma Lamping
United States
kl1491@msn.com

Contact: Karma Lamping
P: 800.999.8200 C: 314.315.6732
kl1491@msn.com

Contact: Default

BUDGET		REQUIRED FOR APPROVAL		
Lead Time: (weeks)	8-10	<input type="checkbox"/> Cutting	<input type="checkbox"/> 	
Bulk Qty:	0 Lin Yds	<input type="checkbox"/> Strike Off	<input type="checkbox"/> 	
Area Qty:	0 Lin Yds	<input type="checkbox"/> Cut Sheet	<input type="checkbox"/> 	
Total Qty:	0 Lin Yds	<input type="checkbox"/> Flame Certification	<input type="checkbox"/> 	
			<input type="checkbox"/> 	
			<input type="checkbox"/> 	

Item Name	Overdrape Face Fabric
Pattern	Santiago FR
Color	Indigo
Content	100% FR- Polyester
Repeat	13.4"Vert.; 13.5"Horz.
Width	54"
Railroad	No
Cleaning Code	Washable
Flammability	Passes NFPA 701

SPECIAL INSTRUCTIONS:

Mirror



Item Report By Item Type

Project:

Project #: 609

Issue Date: 03 FEB 2017

ItemType: Mirror

Control #	Item Name	Total Qty	Unit	Item Cost	Total Cost	Revision Date
MR-1.H	Tall Mirror for Guestrooms	0	Each			
MR-3.H	Desk Mirror	0	Each			



Image Report By Item Type

Project:

Project #: 609

Issue Date: 03 FEB 2017

Item Type: Mirror

MR-1.H



MR-3.H





MR-1.H

Mirror

Project:
Project #: 609

Issue Date: 03 FEB 2017
Revision Date:

Mfr:

Rep:

Contact:

Contact:

Total Qty: 0 Each Area Qty: 0 Each Bulk Qty: 0 Each Lead Time: (weeks)

- Finish Sample
- Strike-Off
- Cutting
- Shop Dwgs
- Prototype
- Seaming Diag
- CAD Drawing
- Cut Sheet
- Flame Certification

Item Name Tall Mirror for Guestrooms
 Frame 3"Width
 Finish Antique Silver
 Dimensions 2'-2"W X 5'-0"H
 SPECIAL INSTRUCTIONS:



AREAS



MR-3.H

Mirror

Project:

Issue Date:

03 FEB 2017

Project #: 609

Revision Date:

Mfr: Majestic Mirror and Frame
7425 NW 79th St.
Miami, FL 33166, United States
P: 305-827-2661 F: 305-827-2663
www.majesticmirror.com

Rep:

Contact:

Contact:

Total Qty: 0 Each

Area Qty: 0 Each

Bulk Qty: 0 Each

Lead Time: (weeks) 8-10

Finish Sample

Strike-Off

Cutting

Shop Dwgs

Prototype

Seaming Diag

CAD Drawing

Cut Sheet

Flame Certification

Item Name: Desk Mirror
Description: Mirror at Desk
Model #: 2433-P
Dimensions: 36" Diameter
Finish: Polished Pewter
Frame: Metallic Ribbed

SPECIAL INSTRUCTIONS:



AREAS

Drapery



Item Report By Item Type

Project:

Project #: 609

Issue Date: 03 FEB 2017

ItemType: Drapery

Control #	Item Name	Total Qty	Unit	Item Cost	Total Cost	Revision Date
DR-1.H	Guestroom Overdrape	0				
DR-2.H	Guestroom Sheer	0				
DR-3.H	Corner King Suite Drapery	0				
DR-4.H	Corner King Suite Sheer	0				
DR-5	Mobility Guestroom Motorized Drapery Hardware	0	Each			30 NOV 2016 (1)



Image Report By Item Type

Project:

Project #: 609

Issue Date: 03 FEB 2017

Item Type: Drapery

DR-1.H

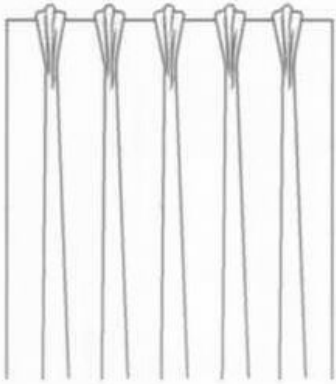

DR-2.H

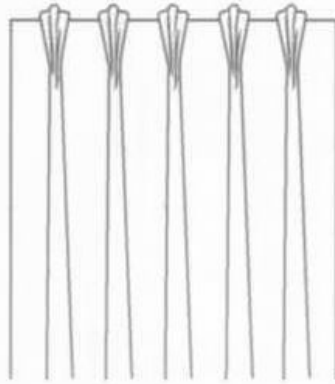

DR-3.H

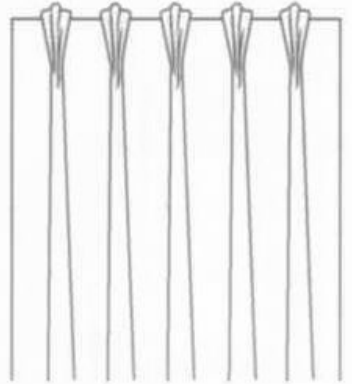

DR-4.H

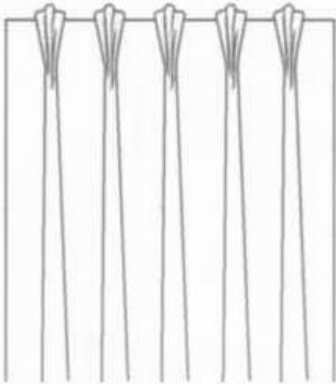

DR-5

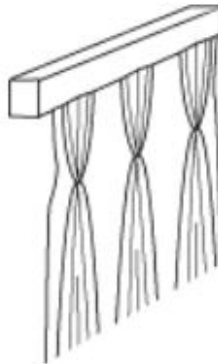



DR-1.H

Drapery

Project:
Project #: 609

Issue Date: 03 FEB 2017
Revision Date:

Mfr:

Rep:

Contact:

Contact:

Total Qty: 0

Area Qty: 0

Bulk Qty: 0

Lead Time: (weeks) 8-10

Finish Sample

Strike-Off

Cutting

Shop Dwgs

Prototype

Seaming Diag

CAD Drawing

Cut Sheet

Flame Certification

Item Name

Guestroom Overdrape

SPECIAL INSTRUCTIONS:

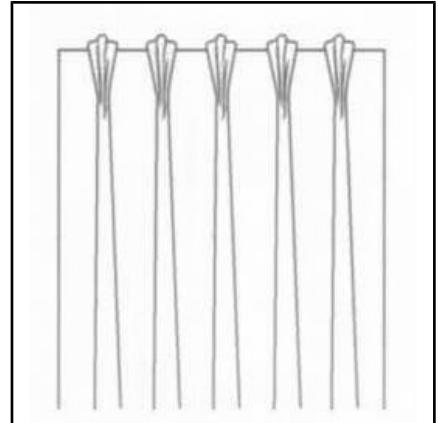

AREAS



1. DESCRIPTION: CENTER DRAW DRAPERY AND SHEER FABRICATION
OVERDRAPE AND SHEER PLEAT STYLE: PINCH PLEAT
LINING FOR OVERDRAPE: TO BE LINED WITH BLACKOUT LINER FABRIC
FULLNESS: 200% (2 TO 1 FULLNESS) INCLUDING SPECIFIED OVERLAPS
AND RETURNS.

PLEATS: TRIPLE-FOLD PINCH PLEATS ARE BAR TACKED 1/2" UP FROM
THE BOTTOM
BUCKRUM. ALL PLEATS ARE EVENLY SPACED ACROSS THE TOP OF THE
DRAPE.

SEAMS: ALL SEAMS ARE OVERLOCKED, SAFETY STITCHED AND HIDDEN.
SEAMS ARE PLACED SO THAT
THEY DO NOT SHOW BETWEEN PLEATS AND NO MORE THAN 1/4" FROM
SIDE OF PLEAT. THEY ARE PRESSED
AND BLOCKED TO AVOID PUCKERING. PATTERNS ARE TO BE PATTERN
MATCHED AT SEAMS, IF APPLICABLE.

HEMS: THE BOTTOM HEM IS BLINDSTITCHED WITH A 4" DOUBLE TURN.
THE SIDE HEMS ARE BLINDSTITCHED WITH A
1-1/2" DOUBLE TURN. COLOR MATCHED THREAD IS TO BE USED ON ALL
TREATMENTS. ALL HEMS ARE PRESSED,
SO THAT THERE IS NO PUCKERING AT THE STITCH LINE. PROVIDE 3/4"
SQUARE HIDDEN SEWN-IN WEIGHTS AT EACH
CORNER OF THE HEM FOR ADDED STABILITY. CORNERS SEWN CLOSED
AT THE HEM USING A BONIS MACHINE.
BEDCHAIN (SHOT-TAPED) IS SEWN INTO BOTTOM OF SHEER HEM FOR
CONTINUOUS WEIGHT.

HARDWARE

PIN HOOKS: PROVIDE HEAVY DUTY, NON-RUSTING, STAINLESS STEEL
PIN HOOKS
DRAPERY WAND: 36" CLEAR BATON FOR TYPICAL GUESTROOMS AND
SUITES;
ACCESSIBLE (ADA) GUESTROOMS AND SUITES TO HAVE 48" CLEAR
BATON

HARDWARE SYSTEM

2 TRACK SYSTEM: CEILING MOUNTED
CONSTRUCTION:
DRAPERY LENGTH TO BE FLOOR TO CEILING
CLEARANCE SPACE BETWEEN BOTTOM OF DRAPE AND FLOOR = 1"
ALL HARDWARE INCLUDING TRACK SYSTEM TO BE PROVIDED BY THE
MANUFACTURER

LABELING: EACH DRAPE WILL HAVE A LABEL SEWN IN AN
INCONSPICUOUS PLACE WITH SIZE
AND ROOM NUMBER CLEARLY MARKED



Project:
Project #: 609

Issue Date: 03 FEB 2017
Revision Date:

Mfr: Fabricut
9303 East 46th Street
Tulsa, OK 74145, United States
P: 800.999.5533
www.fabricutcontract.com

Rep: Karma Lamping
United States
kll1491@msn.com

Contact: Karma Lamping
P: 800.999.8200 C: 314.315.6732
kll1491@msn.com

Contact:

Total Qty: 0 Area Qty: 0 Bulk Qty: 0 Lead Time: (weeks) 8-10

- Finish Sample
- Strike-Off
- Cutting
- Shop Dwgs
- Prototype
- Seaming Diag
- CAD Drawing
- Cut Sheet
- Flame Certification

Item Name Guestroom Sheer

SPECIAL INSTRUCTIONS:

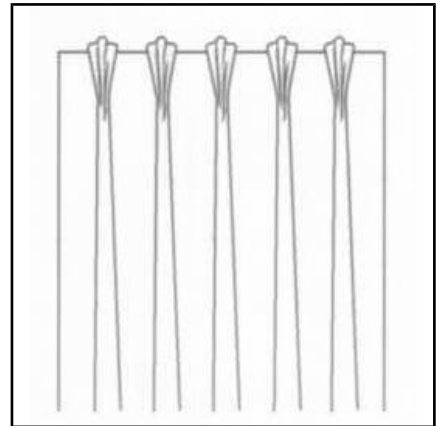

AREAS

1. DESCRIPTION: CENTER DRAW DRAPERY AND SHEER FABRICATION
OVERDRAPE AND SHEER PLEAT STYLE: PINCH PLEAT
LINING FOR OVERDRAPE: TO BE LINED WITH BLACKOUT LINER FABRIC
FULLNESS: 200% (2 TO 1 FULLNESS) INCLUDING SPECIFIED OVERLAPS
AND RETURNS.

PLEATS: TRIPLE-FOLD PINCH PLEATS ARE BAR TACKED 1/2" UP FROM
THE BOTTOM
BUCKRUM. ALL PLEATS ARE EVENLY SPACED ACROSS THE TOP OF THE
DRAPE.

SEAMS: ALL SEAMS ARE OVERLOCKED, SAFETY STITCHED AND HIDDEN.
SEAMS ARE PLACED SO THAT
THEY DO NOT SHOW BETWEEN PLEATS AND NO MORE THAN 1/4" FROM
SIDE OF PLEAT. THEY ARE PRESSED
AND BLOCKED TO AVOID PUCKERING. PATTERNS ARE TO BE PATTERN
MATCHED AT SEAMS, IF APPLICABLE.

HEMS: THE BOTTOM HEM IS BLINDSTITCHED WITH A 4" DOUBLE TURN.
THE SIDE HEMS ARE BLINDSTITCHED WITH A
1-1/2" DOUBLE TURN. COLOR MATCHED THREAD IS TO BE USED ON ALL
TREATMENTS. ALL HEMS ARE PRESSED,
SO THAT THERE IS NO PUCKERING AT THE STITCH LINE. PROVIDE 3/4"
SQUARE HIDDEN SEWN-IN WEIGHTS AT EACH
CORNER OF THE HEM FOR ADDED STABILITY. CORNERS SEWN CLOSED
AT THE HEM USING A BONIS MACHINE.
BEDCHAIN (SHOT-TAPED) IS SEWN INTO BOTTOM OF SHEER HEM FOR
CONTINUOUS WEIGHT.

HARDWARE

PIN HOOKS: PROVIDE HEAVY DUTY, NON-RUSTING, STAINLESS STEEL
PIN HOOKS
DRAPERY WAND: 36" CLEAR BATON FOR TYPICAL GUESTROOMS AND
SUITES;
ACCESSIBLE (ADA) GUESTROOMS AND SUITES TO HAVE 48" CLEAR
BATON

HARDWARE SYSTEM

2 TRACK SYSTEM: CEILING MOUNTED
CONSTRUCTION:
DRAPERY LENGTH TO BE FLOOR TO CEILING
CLEARANCE SPACE BETWEEN BOTTOM OF DRAPE AND FLOOR = 1"
ALL HARDWARE INCLUDING TRACK SYSTEM TO BE PROVIDED BY THE
MANUFACTURER

LABELING: EACH DRAPE WILL HAVE A LABEL SEWN IN AN
INCONSPICUOUS PLACE WITH SIZE
AND ROOM NUMBER CLEARLY MARKED



DR-3.H

Drapery

Project:
Project #: 609

Issue Date: 03 FEB 2017
Revision Date:

Mfr:

Rep:

Contact:

Contact:

Total Qty: 0

Area Qty: 0

Bulk Qty: 0

Lead Time: (weeks)

Finish Sample

Strike-Off

Cutting

Shop Dwgs

Prototype

Seaming Diag

CAD Drawing

Cut Sheet

Flame Certification

Item Name

Corner King Suite Drapery

SPECIAL INSTRUCTIONS:

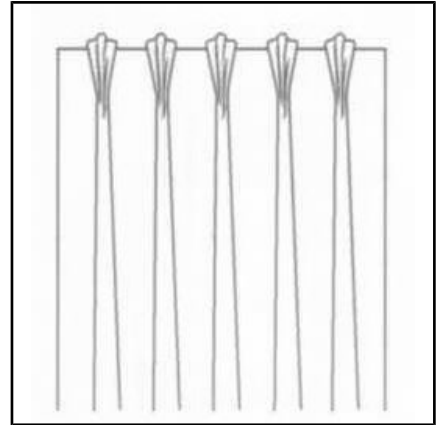

AREAS



DR-4.H

Drapery

Project:
Project #: 609

Issue Date: 03 FEB 2017
Revision Date:

Mfr:

Rep:

Contact:

Contact:

Total Qty: 0

Area Qty: 0

Bulk Qty: 0

Lead Time: (weeks)

Finish Sample

Strike-Off

Cutting

Shop Dwgs

Prototype

Seaming Diag

CAD Drawing

Cut Sheet

Flame Certification

Item Name

Corner King Suite Sheer

SPECIAL INSTRUCTIONS:

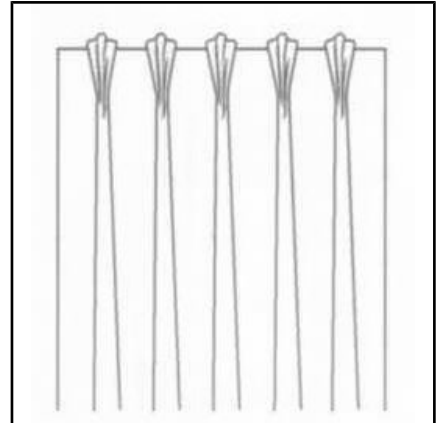

AREAS



DR-5

Revision 1

Drapery

Project: 609

Issue Date: 03 FEB 2017
Revision Date: 30 NOV 2016 (1)

Mfr: Lutron Electronics Co., Inc.
7200 Suter Road
Coppersburg, PA 18036-1299, United States
P: 1-610-282-3800
shadinginfo@lutron.com

Rep:

Contact:

Contact:

Total Qty: 0 Each Area Qty: 0 Each Bulk Qty: 0 Each Lead Time: (weeks) 8-10

- Finish Sample
- Strike-Off
- Cutting
- Shop Dwgs
- Prototype
- Seaming Diag
- CAD Drawing
- Cut Sheet
- Flame Certification

Item Name: Mobility Guestroom Motorized Drapery Hardware

Description: Lutron Motorized Drapery Hardware System

Tracks Required: 1 Track Run for Lined Overdrap; 1 Track Run for Separate Sheer

Pleat Style: Pinch Pleat

Track Style: Straight Track

Draw Style: Center Draw

Drive Style: D175 Drive - Carries up to 175 lbs up to 18' in Length

Power Panel: Lutron Wall Mount Four Button seeTouch Keypad
Open/Close Buttons Required for Overdrap
Open/Close Buttons Required for Separate Sheer

Power Panel Color: (WH) White

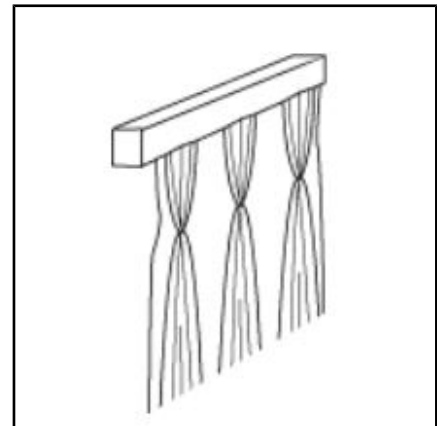

Pinch Pleat - Straight Track

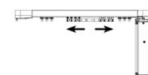

Center Draw Mechanism



4 Button Control

SPECIAL INSTRUCTIONS:

AREAS



Upholstery Report

Project:

Project #: 609

Issue Date:03 FEB 2017

Control #	Item	Area	Location	Qty
F-1.H	King Headboard Fabric			0 Lin Yds
			Total For F-1.H	0.0 Lin Yds
F-2.H	Queen Headboard Fabric			0 Lin Yds
			Total For F-2.H	0.0 Lin Yds
F-3.H	Fabric for Lounge Chair Fronts			8.25 Lin Yds
			Total For F-3.H	8.3 Lin Yds
F-6.H	Fabric for Guestroom Lounge Chair Backs			495 Lin Yds
			Total For F-6.H	495.0 Lin Yds
F-7.H	Fabric for Back of Dining Chair			2
			Total For F-7.H	2.0
F-9.H	Fabric For Desk Chair			4 Lin Yds
			Total For F-9.H	4.0 Lin Yds
F-11.H	Fabric for Suites Lounge Chair, Dining Chair Seat, Ottomans, & Luggage Benches			0 Lin Yds
			Total For F-11.H	0.0 Lin Yds
F-12.H	Fabric For Sofa Sleeper			0 Lin Yds
			Total For F-12.H	0.0 Lin Yds
F-13.H	Fabric For Pillow Sofas Sleepers			0 Lin Yds
			Total For F-13.H	0.0 Lin Yds
F-15.H	Fabric For Sofa Sleeper Ottomans			0 Lin Yds
			Total For F-15.H	0.0 Lin Yds
F-21.H	Overdrape Face Fabric			0 Lin Yds
			Total For F-21.H	0.0 Lin Yds
F-22.H	Overdrape Liner Fabric			0 Lin Yds
			Total For F-22.H	0.0 Lin Yds
F-23.H	Sheer Fabric			0 Lin Yds
			Total For F-23.H	0.0 Lin Yds
F-24.H	Fabric for Scarf Trim & Backing			0
			Total For F-24.H	0.0